



Grange
DEFINING GARDENS



METPOST



**UK PANELS
AVAILABLE NOW
Ask for Details**

Trade Catalogue

**Fencing | Gates | Structures
Planters | Landscaping | Metpost**

Innovative Designs, Market Leading Quality





A MESSAGE FROM THE MANAGING DIRECTOR

With roots stretching back to 1868, Grange Fencing has spent over 150 years doing things properly. We have built our reputation on exceptional craftsmanship, forward-thinking design, and outstanding customer service. As a leader in the industry, we have often been the first to introduce innovations that have gone on to become the standard for others.

Since joining the Stelmet Group in 2014 – Europe’s largest fencing manufacturer – we have enhanced that quality and reliability even further. By applying advanced construction techniques

from our premium ranges and maintaining substantial UK stock, we can guarantee both the highest standards and delivery within five days. This helps our customers remain flexible and confident, whatever the demand.

We are proud to announce the opening of our new manufacturing facility in the UK. Crafted using carefully selected British timber and skilled British craftsmanship, this dedicated facility produces a selected range of products specifically designed for the UK market. Every product is manufactured to the same exacting Grange standards that have defined our reputation for generations.

At Grange, we never stand still. We continue to invest in our products, processes, and customer support. Every piece of fencing is pressure-treated (never dipped) and carries PEFC or FSC certification, ensuring responsible forestry. All our products are backed by a 20-year guarantee against mould and rot.

Our commitment to sustainability runs deeper still. This brochure is printed on fully recyclable materials and is carbon-balanced at the time of printing. It is one small part of our wider promise to help build a greener future.

What truly sets Grange apart is the pride and care we bring to everything we do. Our heritage is more than history – it is a living legacy of trust, dedication, and uncompromising quality. After more than 150 years, our promise remains unchanged: to deliver fencing you can rely on, supported by service you can count on.

At Grange, we strive to be the gold standard in UK landscaping. In the year ahead and beyond, we will continue to raise the bar on quality, reliability, and on-time delivery.

Rolf Behrsing
Managing Director

Contents

Fencing..... 4-13



Gates..... 14-17



Palisade Gates & Fencing..... 18-19



Posts..... 20-21



Metpost..... 22-23



Trellis..... 24-27



Structures & Furniture..... 28-39



Planters & Landscaping..... 40-47



Accessories..... 48-51



Additional Information..... 52-57

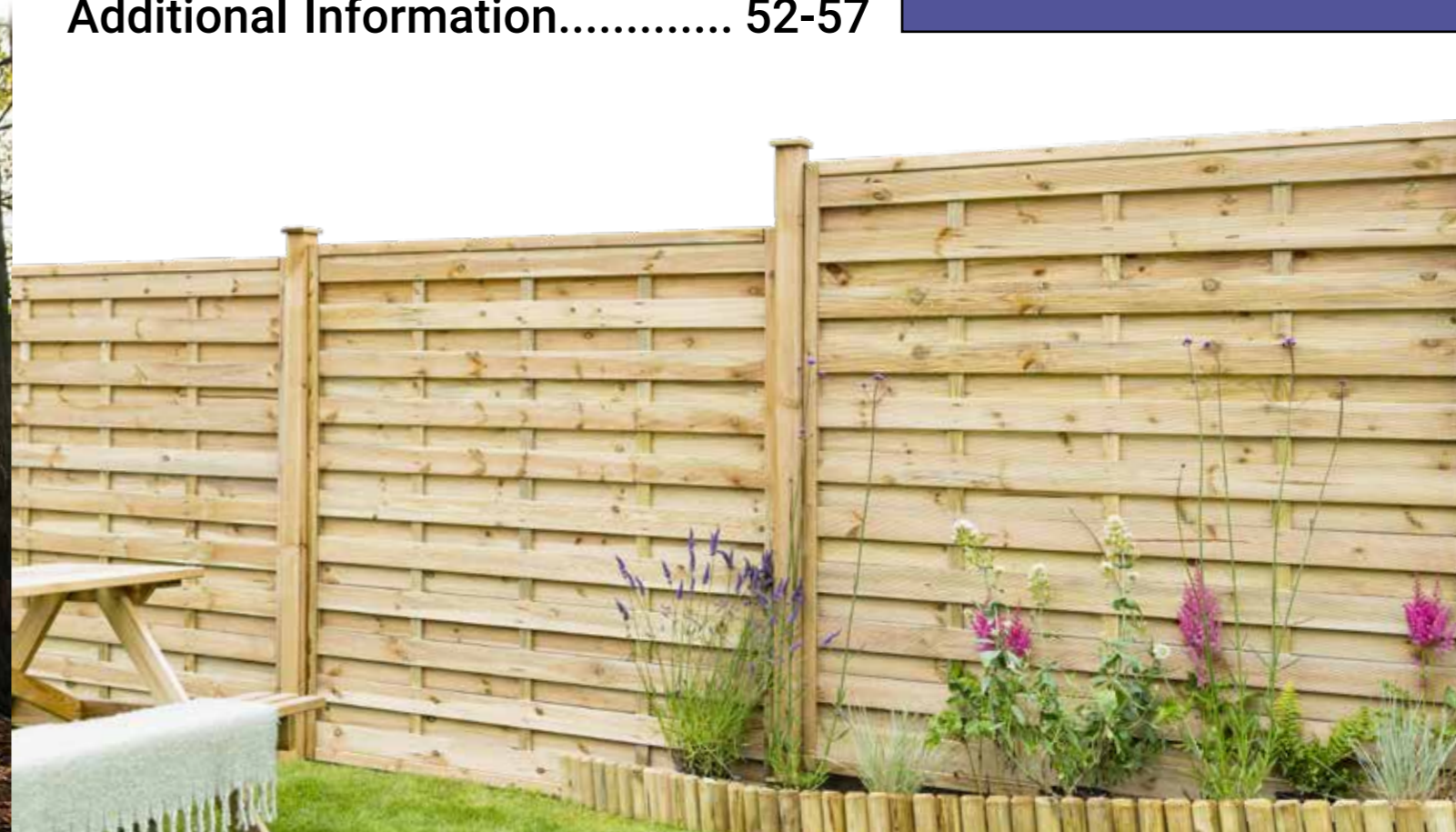
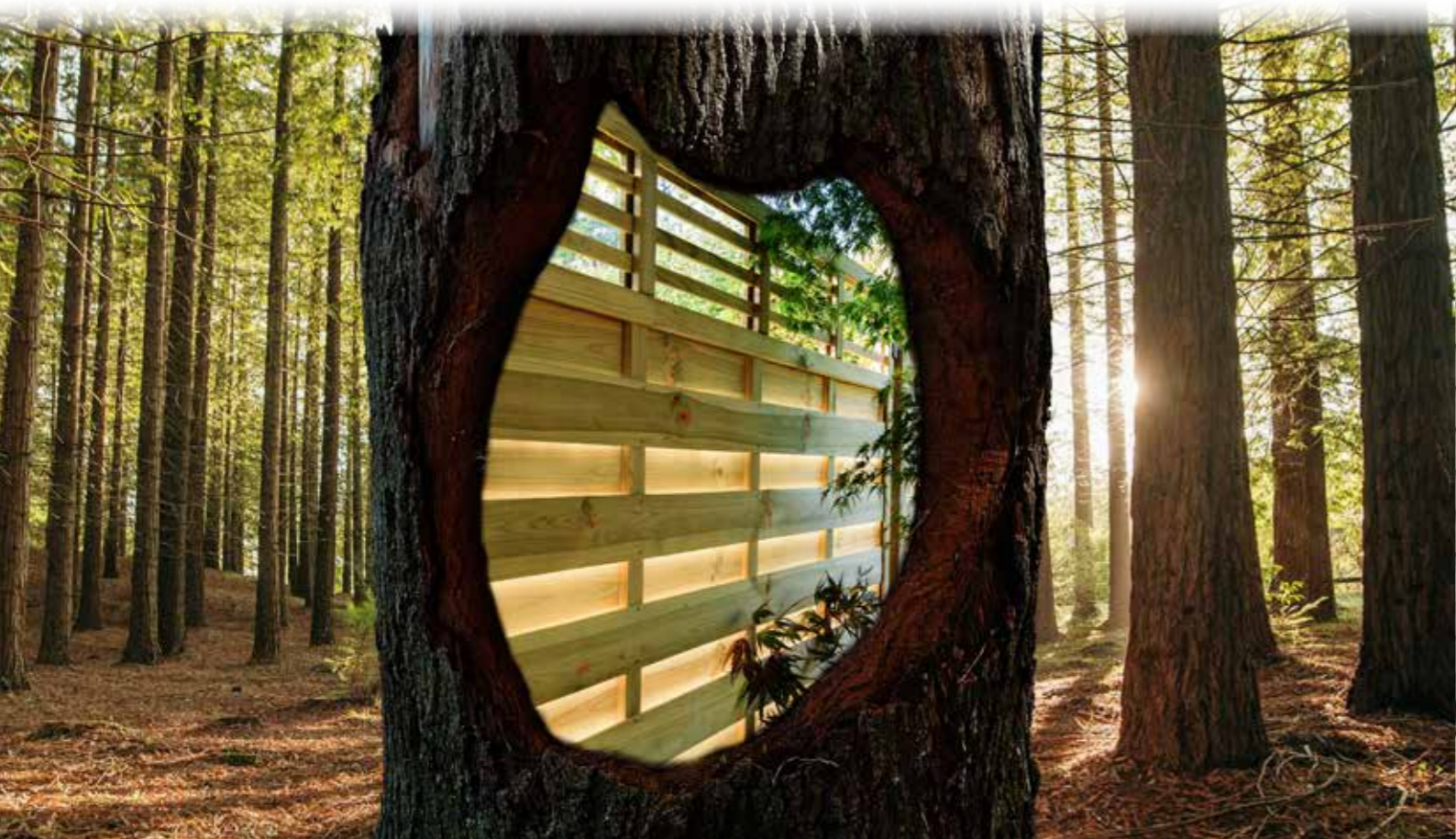



CONTEMPORARY OPTIMA PANEL

This new decorative 'hit and miss' fence panel is designed to offer contemporary style at an affordable price without compromising on aesthetics! The Contemporary Optima panel is the highest quality and offers the greatest privacy for this type of fence, whilst saving time and money compared to using cedar batons.

Pressure Treated Green:
 H180 x W180 x D4.6cm | COPTPAN6
 H90 x W180 x D4.6cm | COPTPAN3
 Supplied as singles

For this product we recommend:
 POST RANGE | EPO*



CONTEMPORARY PANEL

Made to a new and improved specification. This heavyweight, double-slatted fence panel combines a contemporary design with strength, making this the perfect fence for the modern garden.

Pressure Treated Green:
 H179 x W179 x D4.5 cm | CONPAN6
 Supplied as singles

For this product we recommend:
 POST RANGE | EPO*



CONTEMPORARY VOGUE PANEL

The Contemporary Vogue Panel is constructed with a fully mortise and tenon jointed frame and slats on both sides for ultimate privacy.

Pressure Treated Green:
 H120 x W180 x D4.5 cm | CONVPAN4
 H180 x W180 x D4.5 cm | CONVPAN6
 Supplied as singles

For this product we recommend:
 POST RANGE | EPO*



CONTEMPORARY ATCHAM PANEL

A heavyweight fence panel that combines the functionality and look of the Contemporary Vogue Panel with the added feature of a horizontal style trellis top to create a modern twist on an already popular panel.

Pressure Treated Green:
 H180 x W180 x D4.5 cm | CONATCHGRN61
 Supplied as singles

For this product we recommend:
 POST RANGE | EPO*



CONTEMPORARY SCREEN

Offers a contemporary feel to any border or boundary, offering partial levels of privacy.

Pressure Treated Green:
 H180 x W180 x D4 cm | CSCRN6
 Supplied as singles

For this product we recommend:
 POST RANGE | EPO*





ELITE MELOIR PANEL

Offers a quirky decorative design to suit many styles of garden settings.

Pressure Treated Green:

H90 x W180 x D4 cm | ELTMLPAN09
 H105 x W180 x D4 cm | ELTMLPAN11
 H150 x W180 x D4 cm | ELTMLPAN15
 H180 x W180 x D4 cm | ELTMLPAN18

Supplied as singles



For this product we recommend:
 POST RANGE | EPO* / POH*



ELITE MALO PANEL

Created from sturdy horizontal slats and lattice top that features a quality planed, rounded and grooved timber finish.

Pressure Treated Green:

H120 x W180 x D4 cm | ELITEPM12
 H150 x W180 x D4 cm | ELITEPM15
 H180 x W180 x D4 cm | ELITEPM18

Supplied as singles



For this product we recommend:
 POST RANGE | EPO* / POH*



ELITE LILLE PANEL

This panel features straight cut slats that are smooth for a clean feel. The horizontal style trellis top adds an on-trend twist to this simple panel.

Pressure Treated Green:

H180 x W180 x D4 cm | ELTLP18

Supplied as singles



For this product we recommend:
 POST RANGE | EPO* / POH*



ELITE ESPRIT PANEL

Offers a simple design with high levels of privacy, slats are planed, rounded and grooved and are secured into a rebated frame.

Pressure Treated Green:

H90 x W180 x D4 cm | ESMSQ09
 H120 x W180 x D4 cm | ESMSQ12
 H150 x W180 x D4 cm | ESMSQ15
 H180 x W180 x D4 cm | ESMSQ18

Supplied as singles



For this product we recommend:
 POST RANGE | EPO* / POH*



MATCHING CONTEMPORARY PRODUCTS



Gate - page 23



Arch - page 49



Arbour - page 49



Rectangular Planter - page 57



Square Planter - page 58



Tall Planter - page 58

MATCHING ELITE PRODUCTS



6ft Meloir Gate - page 23



3ft Meloir Gate - page 23



Esprit Gate - page 23



Granville Arch - page 50



Elite Arch - page 50



Portico Arch - page 51



Square Trellis - page 33



Meloir Trellis - page 33



Rectangular Planter - page 59



Large Square Planter - page 59



Medium Square Planter - page 60

SUPERIOR FENCING

REVOLUTIONARY DESIGN FEATURES OFFERING A 1ST TO MARKET FENCING SOLUTION WITH A DECORATIVE LOOK.

STRONGER

A fresh take on traditional fence panel designs. Sawn slats securely fitted into a rebated frame creating a stronger panel with increased storm resistance. Neat yet robust panel construction, industry-leading in fact!

At Grange Fencing we are continually reengineering our most popular products to differentiate in a market that is saturated. Our vision is to set new standards in fencing and lead this very stagnant industry.



Rebated frame and Mortise and Tenon joint



Integrated capping rail

Rebated frame prevents water ingress



Capping rail 'popping off'

Prone to water ingress causing critical damage

STRAIGHTER



Faster and easier installation

SMOOTHER



Fine sawn slats for a premium look

PRESSURE TREATMENT

Unlike our competitors, all of our panels are pressure treated, offering added protection from rot, fungal decay and insects.



All of our pressure treated timber products have a 20-year guarantee**

**against rot and fungal decay

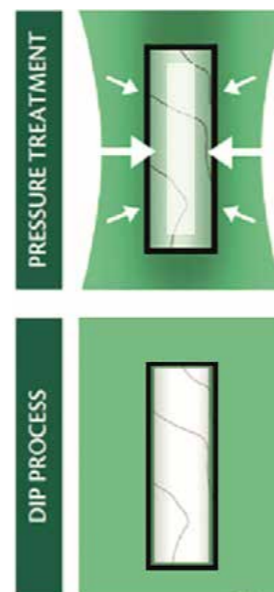

SUPERIORLAP SUPERIOR LAP PANEL

Constructed using double waney edge slats that are secured into a neat fully mortise and tenon-jointed rebated frame, making it stronger than any traditional lap panel before. The Superior Lap has the same neat, attractive look on both the front and back of the panel.

Pressure Treated Golden Brown:
 H60 x W183 x D4 cm | GSL2
 H90 x W183 x D4 cm | GSL3
 H120 x W183 x D4 cm | GSL4
 H150 x W183 x D4 cm | GSL5
 H180 x W183 x D4 cm | GSL6
 Pack Size: 19

Pressure Treated Dark Brown:
 H90 x W183 x D4 cm | GSLDB3
 H120 x W183 x D4 cm | GSLDB4
 H150 x W183 x D4 cm | GSLDB5
 H165 x W183 x D4 cm | GSLDB56
 H180 x W183 x D4 cm | GSLDB6
 Pack Size: 18

Pressure Treated Green:
 H90 x W183 x D4 cm | GSLG3
 H120 x W183 x D4 cm | GSLG4
 H150 x W183 x D4 cm | GSLG5
 H165 x W183 x D4 cm | GSLG56
 H180 x W183 x D4 cm | GSLG6
 Pack Size: 19

For this product we recommend:
 POST RANGE | PO* / PO*G

Panels available in both horizontal and vertical shipping options. To order vertical option please add a 'V' onto the end of the product code.





SUPERIORC'BOARD SUPERIOR CLOSEBOARD PANEL

Revolutionising the closeboard panel market. The Superior Closeboard panel is constructed in a fully mortise and tenon jointed frame, which features an integrated capping rail and fine sawn timber boards for a premium look.

Pressure Treated Golden Brown:

- H90 x W183 x D4 cm | GSCB3N
- H120 x W183 x D4 cm | GSCB4N
- H150 x W183 x D4 cm | GSCB5N
- H180 x W183 x D4 cm | GSCB6N

Pressure Treated Green:

- H90 x W183 x D4 cm | GSCB3NG
- H120 x W183 x D4 cm | GSCB4NG
- H150 x W183 x D4 cm | GSCB5NG
- H180 x W183 x D4 cm | GSCB6NG

Pack Size: 19

For this product we recommend:
POST RANGE | PO* / PO*G



Panels available in both horizontal and vertical shipping options. To order vertical option please add a 'V' onto the end of the product code.



SUPERIORF'EDGE SUPERIOR FEATHEREDGE PANEL

The Superior Featheredge is a game changer for the traditional fencing market. The flawed sandwich style build is replaced by a stronger and more aesthetically pleasing mortise and tenon jointed frame, with the slats recessed into the frame itself.

Pressure Treated Golden Brown:

- H90 x W183 x D4.8 cm | GSFE3V
- H120 x W183 x D4.8 cm | GSFE4V
- H150 x W183 x D4.8 cm | GSFE5V
- H165 x W183 x D4.8 cm | GSFE56V
- H180 x W183 x D4.8 cm | GSFE6V

Pressure Treated Green:

- H90 x W183 x D4.8 cm | GSFE3GV
- H120 x W183 x D4.8 cm | GSFE4GV
- H150 x W183 x D4.8 cm | GSFE5GV
- H165 x W183 x D4.8 cm | GSFE56GV
- H180 x W183 x D4.8 cm | GSFE6GV

Pack Size: 15

For this product we recommend:
POST RANGE | PO* / PO*G

Panels available in vertical shipping only.

Pressure Treated Dark Brown:

- H90 x W183 x D4.8 cm | GSFE3DBV
- H120 x W183 x D4.8 cm | GSFE4DBV
- H150 x W183 x D4.8 cm | GSFE5DBV
- H165 x W183 x D4.8 cm | GSFE56DBV
- H180 x W183 x D4.8 cm | GSFE6DBV





STANDARD FEATHEREDGE PANEL

A stunning panel which is fully framed and features 22 x 100mm wide, featheredge boards and a capping rail.

Pressure Treated Golden Brown:
 H92 x W183 x D5 cm | SFEP3
 H122 x W183 x D5 cm | SFEP4
 H152 x W183 x D5 cm | SFEP5
 H182 x W183 x D5 cm | SFEP6

Pressure Treated Green:
 H92 x W183 x D5 cm | SFEP3G
 H122 x W183 x D5 cm | SFEP4G
 H152 x W183 x D5 cm | SFEP5G
 H165 x W183 x D5 cm | SFEP56G
 H182 x W183 x D5 cm | SFEP6G

Pressure Treated Dark Brown:
 H92 x W183 x D5 cm | SFEP3DB
 H122 x W183 x D5 cm | SFEP4DB
 H152 x W183 x D5 cm | SFEP5DB
 H165 x W183 x D5 cm | SFEP56DB
 H182 x W183 x D5 cm | SFEP6DB

Pack Size: 14

For this product we recommend:
 POST RANGE | PO* / PO*G

Panels available in both horizontal and vertical shipping options. To order vertical option please add a 'V' onto the end of the product code.



PROFESSIONAL LAP PANEL

A stronger panel with three battens and a fully mortise and tenon jointed construction. Available in Pressure Treated Green, designed to be as stylish as it is sturdy.

Pressure Treated Green:
 H90 x W183 x D4 cm | GNPL3G
 H120 x W183 x D4 cm | GNPL4G
 H150 x W183 x D4 cm | GNPL5G
 H180 x W183 x D4 cm | GNPL6G
 Pack Size: 19

For this product we recommend:
 POST RANGE | PO* / PO*G

Panels available in both horizontal and vertical shipping options. To order vertical option please add a 'V' onto the end of the product code.



WESTON FEATHEREDGE

This panel is constructed using 24 x 100 mm wide featheredge boards in a full frame with capping rail.

Pressure Treated Dark Brown:
 H93x W183 x D5 cm | WCB3
 H123 x W183 x D5 cm | WCB4
 H153 x W183 x D5 cm | WCB5
 H183 x W183 x D5 cm | WCB6

Pressure Treated Green:
 H93x W183 x D5 cm | WCB3GRN
 H123 x W183 x D5 cm | WCB4GRN
 H153 x W183 x D5 cm | WCB5GRN
 H183 x W183 x D5 cm | WCB6GRN

Pack Size: 14

For this product we recommend:
 POST RANGE | PO* / PO*G

Panels available in both horizontal and vertical shipping options. To order vertical option please add a 'V' onto the end of the product code.



PLANNING YOUR FENCE

Install your first post using one of the fixing methods shown previously. Attach a string line to the post, take to the furthest position in the run, and fix in place.

The diagram below uses standard 1.83m wide x 1.8m high panels and 75mm posts. Where a dimension falls short of the sizes shown below, a reduced size panel will be required. The method for reducing the size of a panel is shown in Harry's Tip (below).



Plan for any reduced size panels to be situated at the remotest part of the fence.

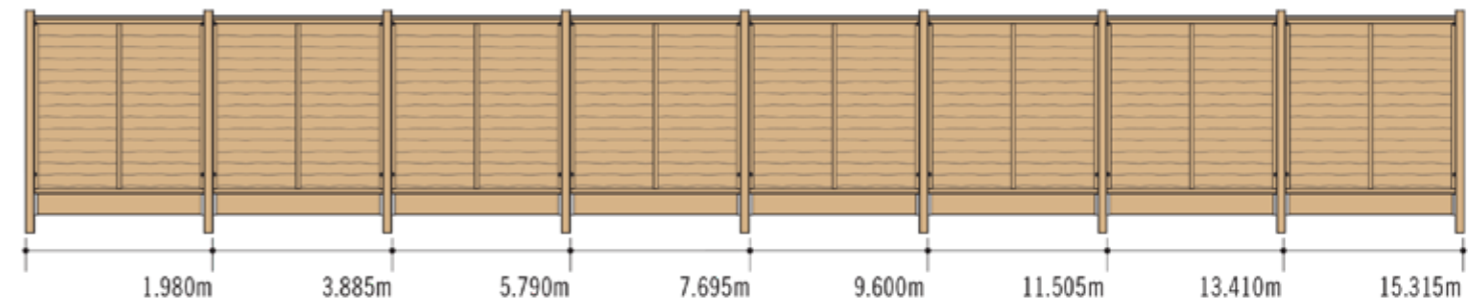



CONTEMPORARY VOGUE GATE

Constructed using a mortise and tenon jointed frame and slats on both sides of the gate for security and durability.

Pressure Treated Green:
H180 x W90 x D4.5 cm | CONVGT

Supplied as singles

For this product we recommend:
POST RANGE | EPO*
HINGE SET | CHGBKIT



ELITE ESPRIT GATE

This gate offers a simple, decorative design ideal for use with the matching Elite St Esprit Fence Panel.

Pressure Treated Green:
H180 x W90 x D4.5 cm | ESMSQGT
Supplied as singles

For this product we recommend:
POST RANGE | EPO*
HINGE SET | CHGBKIT



SUPERIOR LAP GATE

A Lap gate which perfectly compliments the design and strengths of the Superior Lap panels.

H180 x W90 x D3.8 cm
Pressure Treated Golden Brown | GSLGT
Pressure Treated Green | GSLGTG
Pressure Treated Dark Brown | GSLGTDB
Pack Size: 3

For this product we recommend:
POST RANGE | PO*/PO*G
HINGE SET | LHKIT



SUPERIOR FEATHEREDGE GATE

Adopting the build characteristics of the Superior Featheredge panel, this gate is both strong and attractive.

H180 x W90 x D5 cm
Pressure Treated Golden Brown | GSFEGT
Pressure Treated Green | GSFEGTG
Pressure Treated Dark Brown | GSFEGTDB
Supplied as singles

For this product we recommend:
POST RANGE | PO*/PO*G
HINGE SET | LHKIT



ELITE ST MELOIR GATE - 6FT

Offers a simplistic yet decorative design of a domed edged and grooved trellis. Easily hung from either side, the gate features a fully mortise and tenon jointed frame.

Pressure Treated Green:
H180 x W90 x D4.5 cm | ELTMLGT

Supplied as singles

For this product we recommend:
POST RANGE | EPO*
HINGE SET | CVHRKIT / CVHLKIT



ELITE ST MELOIR GATE - 3FT

Offers a simplistic yet decorative design of a domed edged and grooved trellis. Easily hung from either side, the gate features a fully mortise and tenon jointed frame.

Pressure Treated Green:
H98.5 x W90 x D4.5 cm | ELTMLGT3

Supplied as singles

For this product we recommend:
POST RANGE | EPO*
HINGE SET | CVHRKIT / CVHLKIT



SUPERIOR CLOSEBOARD GATE

A Closeboard gate which perfectly compliments the design and strengths of the Superior Closeboard panels.

H180 x W90 x D3.8 cm
Pressure Treated Golden Brown | GSCBGT
Pressure Treated Green | GSCBGTG
Pack Size: 3

For this product we recommend:
POST RANGE | PO*/PO*G
HINGE SET | LHKIT

YOU MIGHT ALSO NEED:



'SUFFOLK'
LATCH & HINGE
FITTINGS KIT |
LHKIT

Pack contains:
2x T Hinges 10", 1x 'Suffolk' Latch, Screws
Pack size: 10

CURVED HINGE
FITTINGS KIT |
CVHRKIT (RHS) /
CVHLKIT (LHS)



Available for both right hanging or left hanging gates.
Pack contains:
1x Top Curve Hinge, 1x Bottom Hinge, Screws
Pack size: 10



SIDE ENTRY ARCH GATE

The Side Entry Arch Gate is a heavy duty gate which benefits from a sturdy mortise and tenon jointed frame.

H184 x W90 x D3.8 cm
Pressure Treated Golden Brown | SEAR6
Pack Size: 3

For this product we recommend:
POST RANGE | PO8
HINGE SET | CHGBKIT



TONGUE AND GROOVE LEDGED & BRACED GATE

The sturdy tongue and groove structure provides this gate with it's strength and durability.

H180 x W90 x D5.2 cm
Pressure Treated Green | TGLBG
Pack Size: 3

For this product we recommend:
POST RANGE | PO8
HINGE SET | LHKIT



ARCHED FEATHEREDGE GATE

Ideal for use in conjunction with all Grange Featheredge panels.

H180 x W90 x D6.2 cm
Pressure Treated Green | AFG6
Pack Size: 3

For this product we recommend:
POST RANGE | PO8
HINGE SET | CHGBKIT



CLOSEBOARD GATE

A classic vertical board gate with fine sawn timber for a smooth finish.

H181.5 x W90 x D3.8 cm
Pressure Treated Golden Brown | SEC6
Pack Size: 3

For this product we recommend:
POST RANGE | PO8
HINGE SET | LHKIT



How to hang a timber gate

Gates usually provide a dual function. To restrict access to certain areas or to keep in children and/or pets.

Grange offers a wide range of both 6' and 3' high gates. The choice depends on your specific requirements but the basic installation methods will be the same, whatever style you choose.

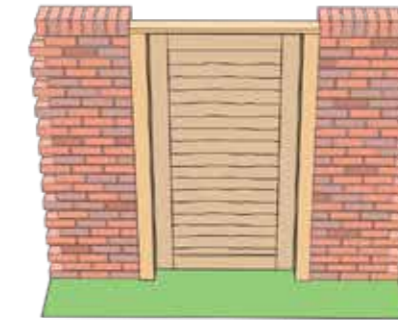

Tools required:

- Tape measure
- Power drill
- Spirit level

MEASURING FOR A TIMBER GATE

When measuring for a gate remember to add the two post sizes to the gate size and a further 20mm overall spacing to allow the gate to freely open and close.

Free standing posts for 6' gates should be at least 100 x 100mm (4" x 4"). Supported posts, either with a top cross member or at the sides, may be smaller. If using a top cross member, it should be at least 2m (6' 6") off ground level.

The hole size for each post should be 600mm deep and 300mm wide. Concrete in the posts with MetCrete or a similar post fix concrete.

Posts may also be fixed to an existing wall.

Ensure the posts are vertically parallel before attempting to fit the gate.

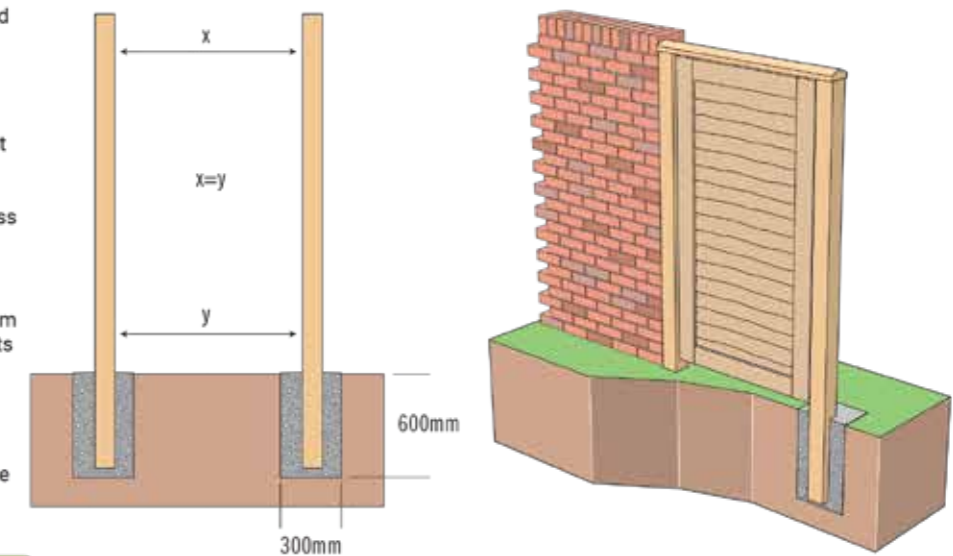

FITTING THE GATE

Position the gate between the posts and place some 50mm packers under it. Allow for any unevenness in the ground when the gate is opened.

Now place wedges either side of the gate to even out the gaps either side and to hold the gate in place while fitting the hinges (3).

Fit the hinges, taking care to ensure that the gate opens as intended. Remove all spacers and wedges and check that the gate swings freely.

Fit the latch to the gate at the preferred height and in a position where the gate can support the screws. Fit the keep to the post.

Finally, fit a gate stop to the frame/post to protect the hinges and latch from damage.

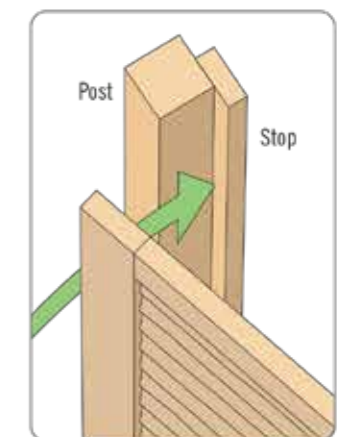
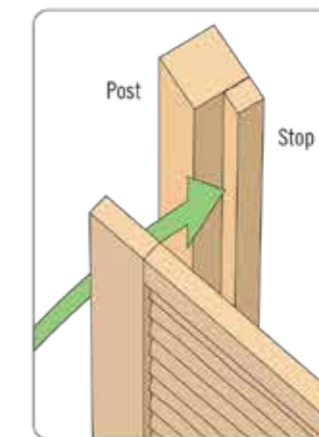
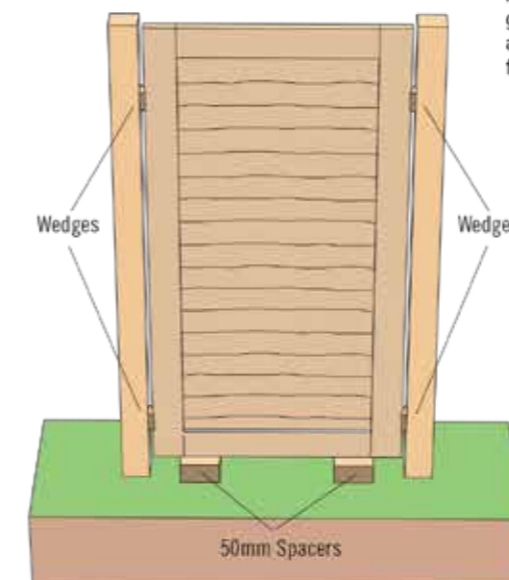

PALISADE FENCING & GATES



ROUND TOP PALISADE PANEL

Ideal for constructing a new fence run or repairing an existing one, making your garden a private space to relax in.

Pressure Treated Green:

H90 x W180 x D4.4 cm | RTP09

H120 x W180 x D4.4 cm | RTP12

Pack Size: 18

H80 x W180 x D3.2 cm | RTP08G

Pack Size: 20

For this product we recommend:
POST RANGE | RTPPOST



ROUND TOP PALISADE GATE

Our traditional style Round Top Palisade gate can be used alongside a matching fence panel to complete the look.

Pressure Treated Green:

H90 x W90 x D4 cm | RTPGT

Pack Size: 5

For this product we recommend:
POST RANGE | RTPPOST



PALE GATE

The Pale gate is versatile and great to use with a variety of styles of fencing.

Pressure Treated Green:

H90 x W90 x D4.5 cm | PALEG0991

Pack Size: 3

For this product we recommend:
POST RANGE | P06G
HINGE SET | THKIT



SOLID INFILL PATH GATE

Simple, clean lines crafted from planed timber with the option to hang from either side.

Pressure Treated Green:

H90 x W90 x D4.5 cm | SOLPALGT

Pack Size: 3

For this product we recommend:
POST RANGE | P06G
HINGE SET | THKIT



PALISADE PANEL TULIP

Manufactured from finely sawn timber, the Tulip offers a stylish but modern design of fencing for your garden.

Pressure Treated Golden Brown:

H90 x W183 x D3.5 cm | PALTUL3

Pack Size: 20

For this product we recommend:
POST RANGE | PALEPTUL5GB



PALISADE TULIP GATE

Designed to blend seamlessly with the Palisade Panel Tulip for a consistent and attractive run of fencing.

Pressure Treated Golden Brown:

H90 x W87.5 x D4.8 cm | PALGT3

Pack Size: 3

For this product we recommend:
POST RANGE | PALEPTUL5GB
HINGE SET | THKIT



DOME LEDGED & BRACED PATH GATE

A domed top gate with a simple, yet rustic, feel. Ideal to use along a pathway or entrance.

Pressure Treated Green:

H105 x W90 x D3.6 cm | DOMLBGT

Pack Size: 3

For this product we recommend:
POST RANGE | P06G
HINGE SET | THKIT



YOU MIGHT ALSO NEED:



HINGE & AUTO LATCH FITTINGS KIT | THKIT

Pack contains:

2x T Hinges 10", 1x Auto Latch, Screws

Pack size: 10



ELITE GROOVED FENCE PANEL POST

This post has a rounded top and features and decorative grooving on the front and back to complement the Elite range of trellis and fencing.
 Pressure Treated Green:
 H240 x W7 x D7 cm | EPO8
 Supplied as singles

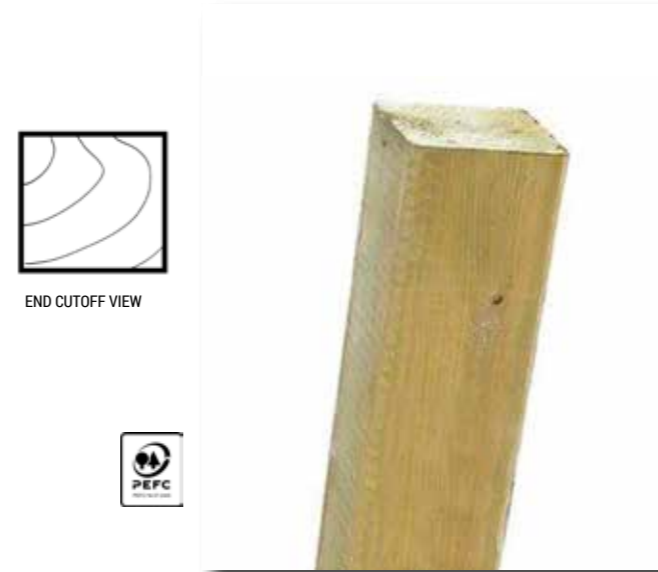

ELITE FENCE PANEL POST

A chunky 95 mm square post that is planed for a contemporary look and feel.
 Pressure Treated Green:
 H180 x W9.5 x D9.5 cm | EPO64
 H240 x W9.5 x D9.5 cm | EPO84
 Supplied as singles



Please note

Product codes PO6, PO62, PO8, PO10, PO104 are FSC Certified
 Remaining product codes are PEFC Certified

TIMBER FENCE PANEL POST

This square timber post of sturdy and ideal for use with fence panels and gates. Available in 3 widths to suit your project requirements.

100MM SQ

Pressure Treated Dark Brown:
 H180 x W10 x D10 cm | PO64
 H240 x W10 x D10 cm | PO84
 H300 x W10 x D10 cm | PO104
 Pressure Treated Green:
 H240 x W10 x D10 cm | PO84G
 Pack size: 12

75MM SQ

Pressure Treated Dark Brown:
 H180 x W7.5 x D7.5 cm | PO6
 H240 x W7.5 x D7.5 cm | PO8
 Pack size: 48
 H300 x W7.5 x D7.5 cm | PO10
 Pack size: 15
 Pressure Treated Green:
 H180 x W7.5 x D7.5 cm | PO6G
 H240 x W7.5 x D7.5 cm | PO8G
 Pack size: 15

50MM SQ

Pressure Treated Dark Brown:
 H180 x W5 x D4.7 cm | PO62
 H240 x W5 x D4.7 cm | PO82
 Pack size: 48

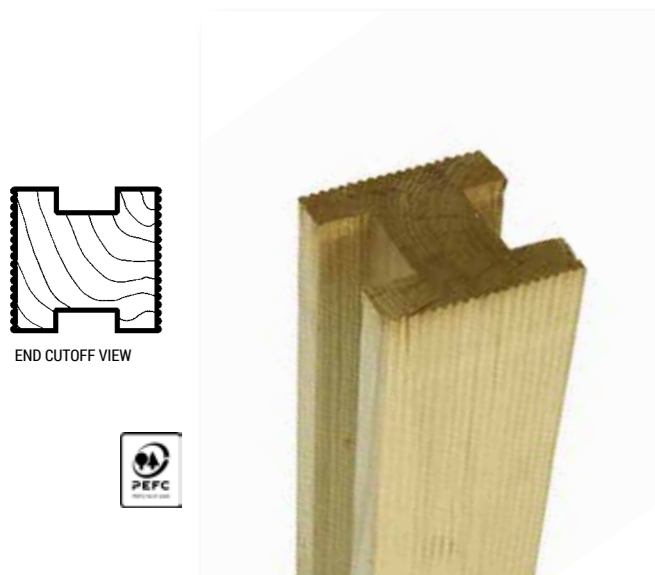

ELITE GROOVED FENCE PANEL H POST

The 'H' shaped post allows for fence panels to easily slot in place without the need for metal U-clips.

*This product is not suitable for Contemporary style panels
 Pressure Treated Green:
 H180 x W9 x D9 cm | POH64
 H240 x W9 x D9 cm | POH84
 Supplied as singles

YOU MIGHT ALSO NEED:

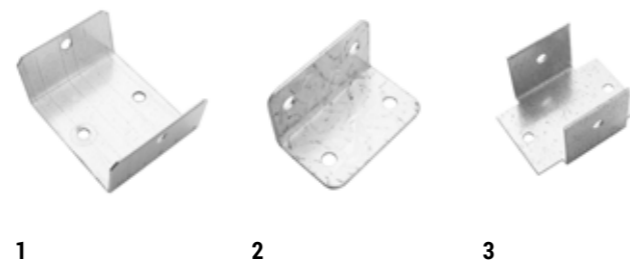

METPOST FIXING CLIPS

1. U-shaped clip 41 mm | 1108
 2. U-shaped clip 46 mm | 1109
 3. U-shaped clip 52 mm | 1110
- Items 1-3 - Pack size: 250



TULIP PALISADE PANEL POST

The Tulip Palisade Post has been specifically designed to suit the Tulip Palisade Fence with pre-cut grooves perfect for slotting panels.

Pressure Treated Dark Brown:
 H150 x W7.5 x D4.8 cm | PALEPTUL5
 Pack size: 1
 Pressure Treated Golden Brown:
 H150 x W7.5 x D4.8 cm | PALEPTUL5GB
 Pack size: 1



ROUND TOP PALISADE POST

The Round Top Palisade Post is ideally used with the Round Top Palisade Panel to give the look of a seamless fence run.

Pressure Treated Green:
 H150 x W7 x D7 cm | RTPPOST
 Pack size: 48

TYPE OF GROUND

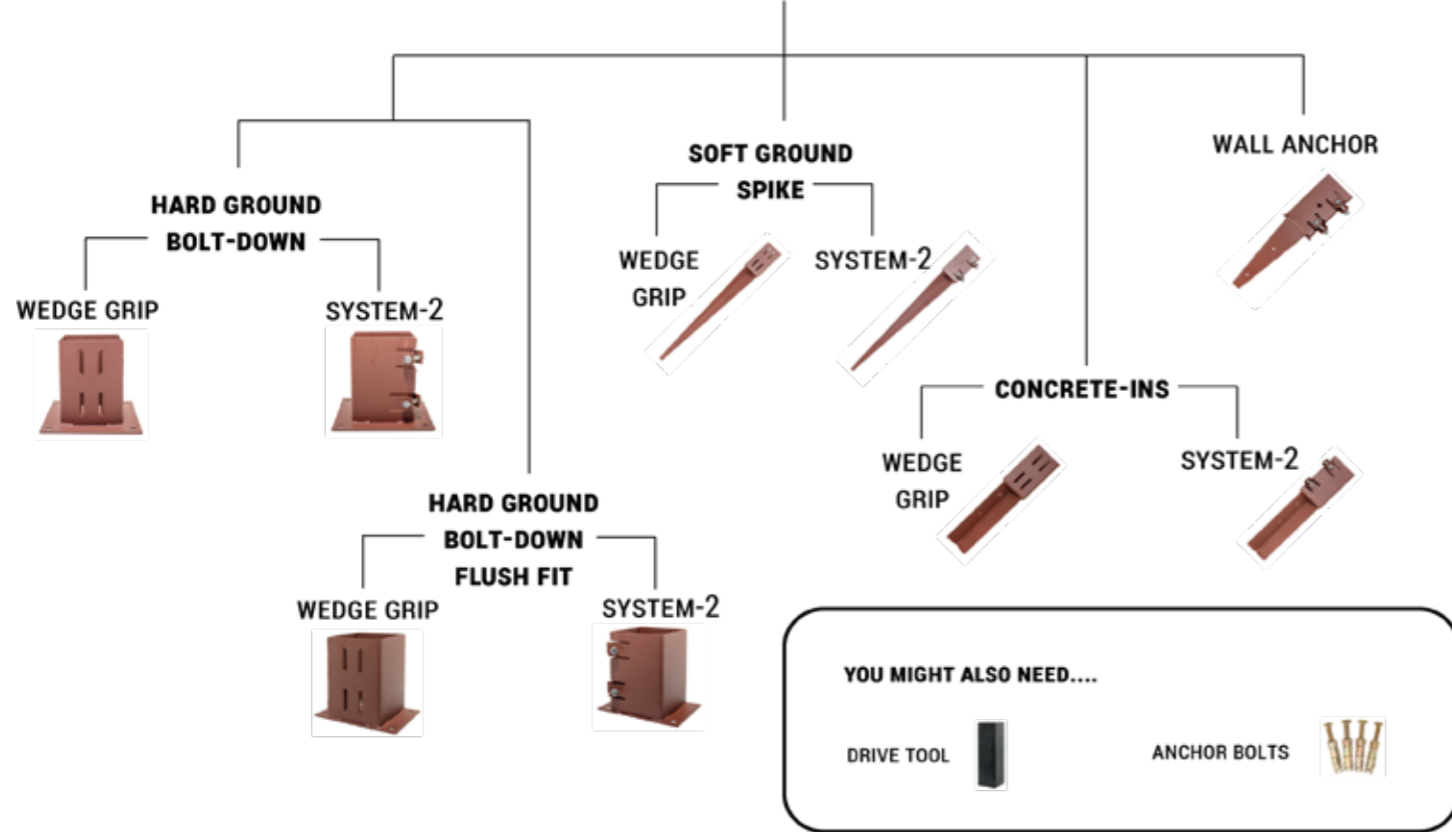

YOU MIGHT ALSO NEED....

DRIVE TOOL ANCHOR BOLTS



POST SUPPORT: SYSTEM 2
 System 2's secure twin bolt mechanism is ideal for large projects such as pergolas and decking.
 1. 75mm post: 600 mm spike | 1006 (Height:75cm - Width: 6cm) Pack size: 10
 2. 75mm post: 750 mm spike | 1007 (Height: 75cm - Width: 7.5cm) Pack size: 10
 3. 100 mm post: 750 mm spike | 10032 (Height: 75cm - Width: 10cm) Pack size: 5



POST SUPPORT: THE WEDGE GRIP
 Ideal for fencing projects, the Wedge holds each post in a vice without the need for nails or screws.
 1. 75 mm post: 600mm spike | 1106 (Height: 75cm - Width: 6cm) Pack size: 10
 2. 75 mm post: 750mm spike | 1107 (Height: 75cm - Width: 7.5cm) Pack size: 10
 3. 100 mm post: 750mm spike | 11032 (Height: 75cm - Width: 10cm) Pack size: 5



CONCRETE-INS
 Secure the anchor into the ground with concrete for a secure, permanent fixing.
 1. Wedge Grip for 73-78 mm posts | 1123 (Height: 37.3cm) Pack size: 10
 3. System 2 for 73-78 mm posts | 2123 (Height: 37.3cm) Pack size: 10
 4. System 2 for 99-103 mm posts | 2124 (Height: 31.4cm) Pack size: 10



BOLT DOWNS
 Plan the position of your Bolt Downs. Secure your surface using Anchor Bolts.
 System-2 for 73-78 mm posts | 1040 (Height: 15cm - Base: 15cm sq.) Pack size: 10
 System-2 for 99-103 mm posts | 1041 (Height: 15cm - Base: 17cm sq.) Pack size: 10



Wedge Grip for 73-78 mm posts | 1140 (Height: 15.5cm - Base 15cm sq.) Pack size: 10
 Wedge Grip for 99-103 mm posts | 1141 (Height: 15cm - Base 17cm sq.) Pack size: 10



Plain Box for 50 mm posts | 1142 (Height: 12.6cm - Base: 15cm sq) Pack size: 10



FLUSH FITTING BOLT DOWNS
 Enables you to site a post against a wall.
 System 2 for 73-78 mm posts | 3110 (Height: 9cm - Base: 15cm) Pack size: 10
 System 2 for 99-103 mm posts | 4110 (Height:11.4cm - Base: 17cm) Pack size: 10



FLUSH FITTING BOLT DOWNS
 Enables you to site a post against a wall.
 Wedge Grip for 73-78 mm posts | 3111 (Height: 9cm - Base: 15cm) Pack size: 10



WALL ANCHOR
 A simple way to add height to a wall.
 System 2 for 73-78 mm posts | 5110 (Height: 32cm - Width: 7.5cm) Pack size: 10



REPAIR SPUR
 Repair a broken or rotten post which has previously been concreted into the ground.
 Wedge Grip for 75 mm: 78 mm posts | 1153 (Height: 45cm - Width: 7.8cm) Pack size: 10
 Wedge Grip for 99 mm: 103 mm posts | 1154 (Height: 53cm - Width 10.3cm) Pack size: 10



ELITE SQUARE LATTICE

Made from planed, chamfered and grooved timber, providing a beautiful decorative finish. Designed to compliment the Elite range of products.

Pressure Treated Green:

H30 x W180 x D4 cm | ELTSQL1
 H60 x W180 x D4 cm | ELTSQL2
 H90 x W180 x D4 cm | ELTSQL3
 H120 x W180 x D4 cm | ELTSQL4
 H180 x W180 x D4 cm | ELTSQL6

Supplied as singles

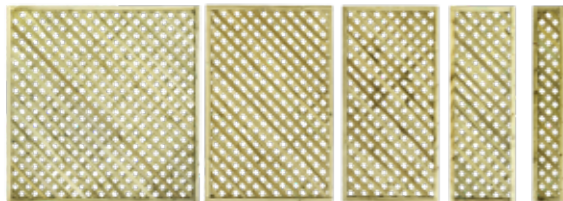

ELITE ST MELOIR BOW TOP LATTICE

The trellis is planed, chamfered and grooved providing a beautiful decorative finish for multiple uses.

Pressure Treated Green:

H60 x W180 x D4 cm | ELITEMLT2
 H105 x W180 x D4 cm | ELITEMLT4
 H180 x W180 x D4 cm | ELITEMLT6

Supplied as singles



ALDERLEY LATTICE TRELLIS

An attractive lattice, joint framed trellis available in various sizes. A part of the Valencia Garden Collection.

Pressure Treated Green:

H30 x W183 x D3 cm | ALDSQ1
 H60 x W183 x D3 cm | ALDSQ2
 H90 x W183 x D3 cm | ALDSQ3
 H120 x W183 x D3 cm | ALDSQ4
 H180 x W183 x D4 cm | ALDSQ18

Supplied as singles

Lattice dimensions: 2cm x 8mm
 Trellis holes: 4cm sq.



ALDERLEY DOME TRELLIS

An attractive lattice, joint framed trellis, a part of the Valencia Garden Collection.

Pressure Treated Green:

H50 x W183 x D3 cm | ALDDOME

Supplied as singles

Lattice dimensions: 2cm x 8mm
 Trellis holes: 4cm sq.



ALDERLEY FAN TRELLIS

Featuring a beautifully crafted lattice, the Alderley Fan Trellis is ideal for mounting on fence panels or walls as well as being used with a planter to support plants.

Pressure Treated Green

H180 x W60 x D3 cm | ALDFAN

Supplied as singles

Lattice dimensions: 2cm x 8mm
 Trellis holes: 4cm sq.
 Height to shoulder: 172cm

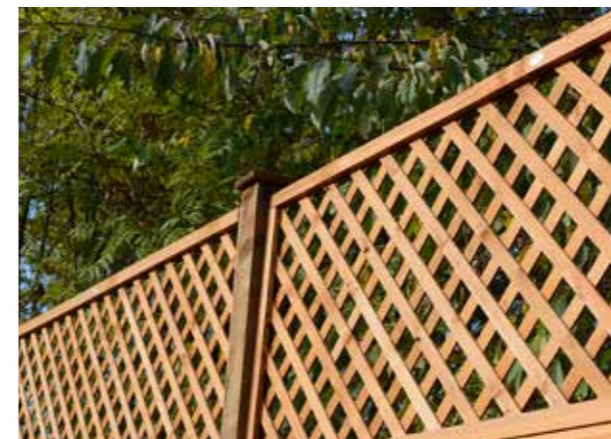

SQUARE HIGHGROVE TRELLIS

This trellis has a rebated double frame for extra strength and manufactured from fine sawn timber for an extra smooth finish. Ideal as a privacy screen.

Pressure Treated Golden Brown:

H32 x W183 x D4 cm | HSQ1
 H61 x W183 x D4 cm | HSQ2

Pack size: 5

Trellis holes: 4.5cm sq.



SQUARE BADMINTON TRELLIS

Great as a fence top, privacy screen or supporting climbing plants. The Badminton Trellis is manufactured from fine sawn timber that provides a smooth and exceptional finish.

Pressure Treated Golden Brown

H62 x W183 x D3 cm | BADSQ61

Pack Size: 5

Trellis holes: 4.5cm sq.
 Slats: 1.5cm



SLATTED TRELLIS

This stylish trellis is perfect for supporting climbing plants, creating privacy screens, or adding a touch of modern design to your outdoor space.

Pressure Treated Green:

H180 x W30 x D2 cm | STP3 - NEW
 H180 x W60 x D2 cm | STP6 - NEW
 H180 x W90 x D2 cm | STP9 - NEW

Pack Size: 10





LILLESHELL LATTICE TRELLIS

This trellis is ideal as a privacy screen to zone off areas within the garden. Along with style, this trellis has a strong rebated frame structure.

Pressure Treated Green:

- H30 x W183 x D3 cm | LILLAT03
- H60 x W183 x D3 cm | LILLAT06
- H90 x W183 x D3 cm | LILLAT09
- H120 x W183 x D3 cm | LILLAT12
- H150 x W183 x D3 cm | LILLAT15
- H180 x W183 x D4.5 cm | LILLAT18

Supplied as singles

Lattice dimension: 2cm x 8mm
Trellis holes: 2cm sq.



HEAVY DUTY SQUARE TRELLIS

This heavy duty trellis with a robust frame is ideal for supporting climbing plants. The fine sawn timber provides a smooth, superior finish.

Pressure Treated Green:

- H32 x W183 x D3 cm | HDT1G
- Pack size: 10
- H61 x W183 x D3 cm | HDT2G
- H90 x W183 x D3 cm | HDT3G
- H120 x W183 x D3 cm | HDT4G
- H151 x W183 x D3 cm | HDT5G
- H181 x W183 x D3 cm | HDT6G
- Pack size: 5

Pressure Treated Golden Brown:

- H32 x W183 x D3 cm | HDT1
- Pack size: 10
- H61 x W183 x D3 cm | HDT2
- H90 x W183 x D3 cm | HDT3
- H120 x W183 x D3 cm | HDT4
- H151 x W183 x D3 cm | HDT5
- H181 x W183 x D3 cm | HDT6
- Pack size: 5

Trellis thickness: 3cm
Batons: 3.2 x 1.5 cm



DIAGONAL TRELLIS

This Art-Deco inspired trellis is ideal for supporting climbing plants. The fine sawn timber provides a smooth, superior finish.

Pressure Treated Green:

- H180 x W60 x D2.8 cm | NT6
- Pack size: 26



HEAVY DUTY FAN TRELLIS

This fan shape trellis allows plants to be supported in a more interesting and natural shape with a new and improved, fine sawn timber finish.

Pressure Treated Golden Brown:

- H180 x W95 x D3 cm | HDFAN
- Pack size: 5





How to install trellis

Trellis has many uses in a garden. It can provide a framework for climbing plants, conceal unsightly areas or act as a division between garden areas. It may also be used to add height to an existing fence – either as a decorative feature or to provide more privacy.

Tools required:

- Tape measure
- Spirit level
- Power drill and masonry bit
- Hammer

Materials required:

- Trellis
- Grange 50 x 50mm timber posts are ideal for use as battens
- Exterior Screws
- Galvanised Nails

FIXING TRELLIS TO A WALL

Wall mounted trellis requires a space between it and the wall to allow plants to grow behind it. The trellis should be mounted on wooden battens to provide this space. The battens should be mounted on the wall vertically so that they do not restrict plant growth. Determine the number of battens required – space at approximately 600mm apart.

Offer the trellis up to the wall in the desired position and mark where it will be. Fix the battens to the wall using screws and wall plugs. Fix the trellis to the battens using galvanised nails.

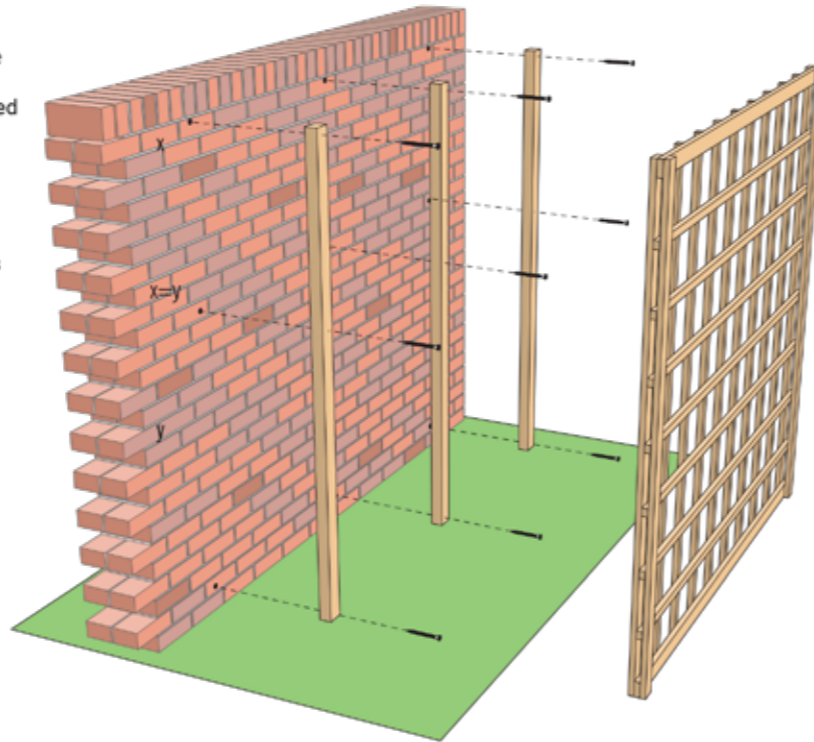
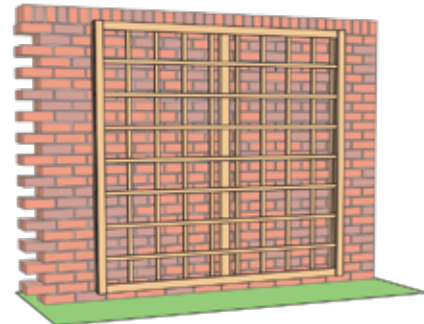

FIXING TRELLIS OUT FROM A WALL

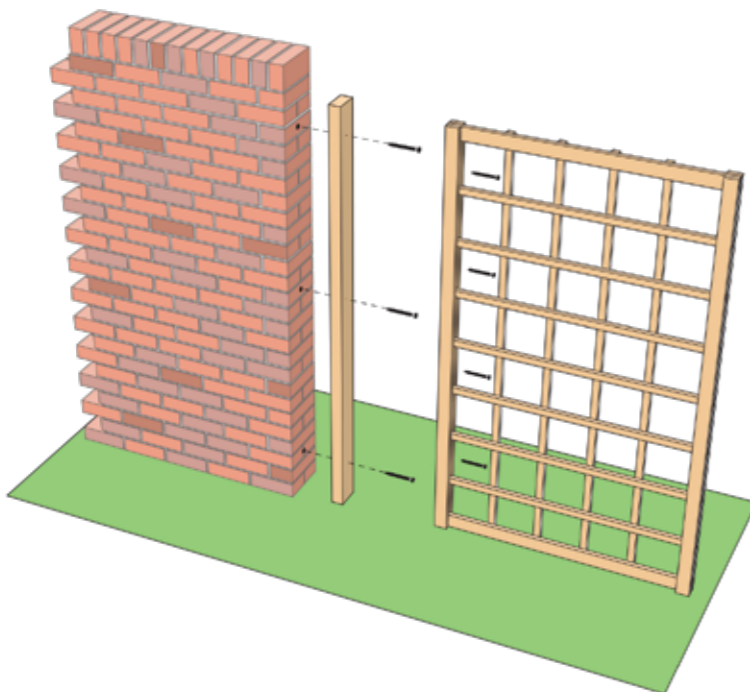

Fix a vertical batten to the wall using screws and wall plugs, the batten should be the same length as the trellis.

Fix the trellis to the batten using screws at equally spaced intervals of approximately 300mm.

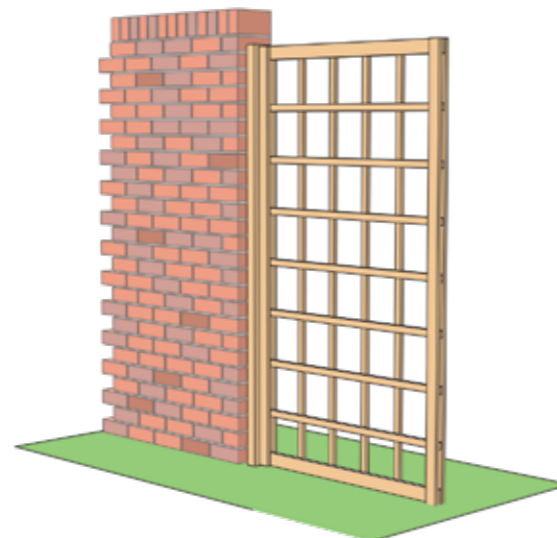

1. When fixing trellis to a wall use battens to create a gap allowing plants to grow.

2. When fixing trellis to a house wall ensure battens are fixed above the damp proof course.

3. The appearance of any post is enhanced by the addition of a Grange Post Cap.

FIXING TRELLIS TO AN EXISTING FENCE

It will be necessary to extend the existing posts to add the trellis. Use Metpost Post Extenders and a piece of extra post to gain the required height.

Fix the trellis to the extended post with Metpost Metclips or screws. Use a Grange Post Cap to the top of the post to add a decorative finish and protect the top of the post.

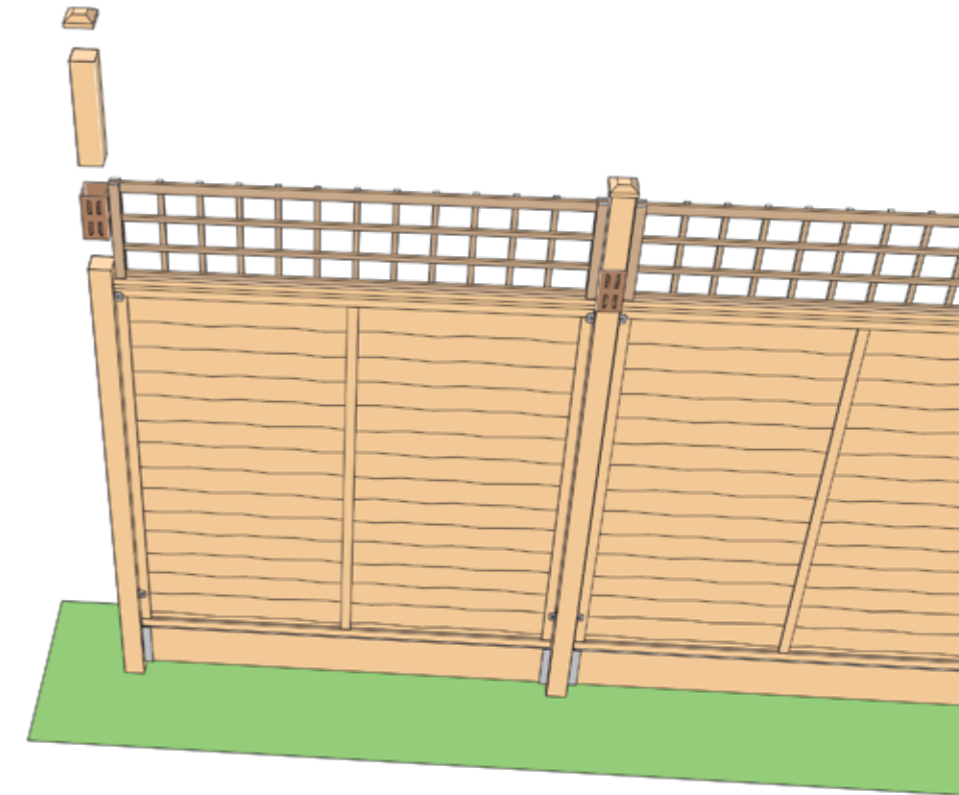
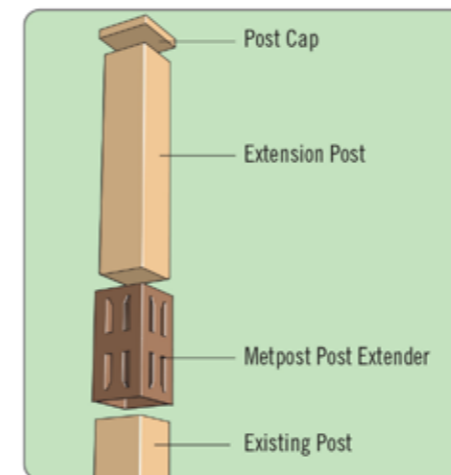

FREESTANDING TRELLIS

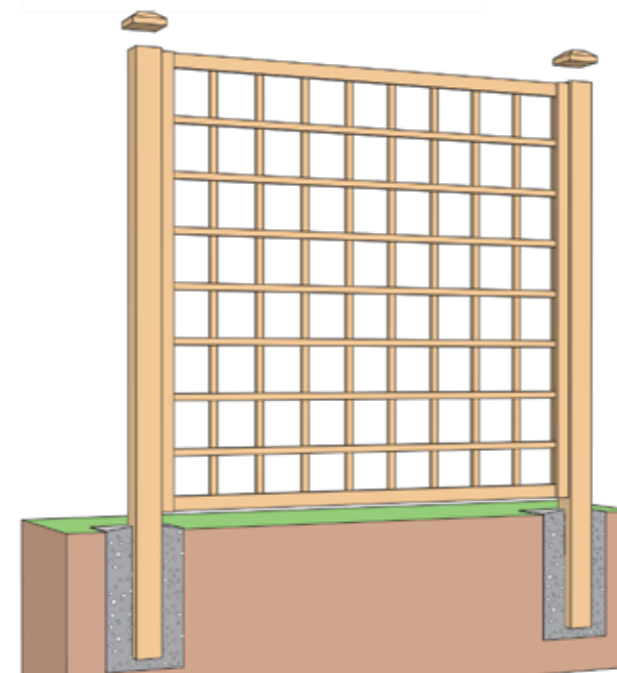

To use trellis as a free standing feature or decorative fence it will be necessary to support it using posts fixed into the ground.

A minimum post size of 50mm x 50mm will be required.

Fix the posts using MetCrete Post Fix Concrete or Metpost post supports.

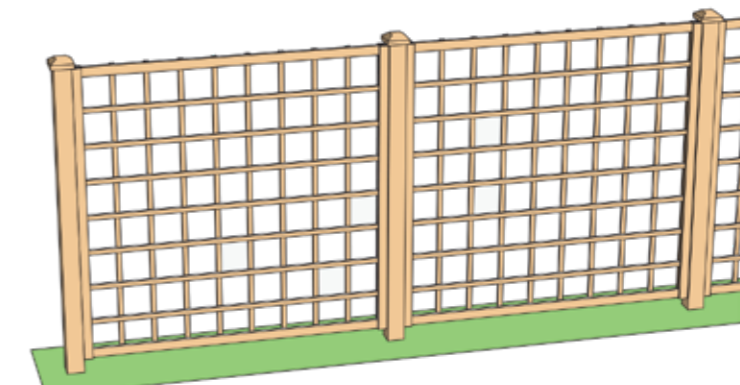

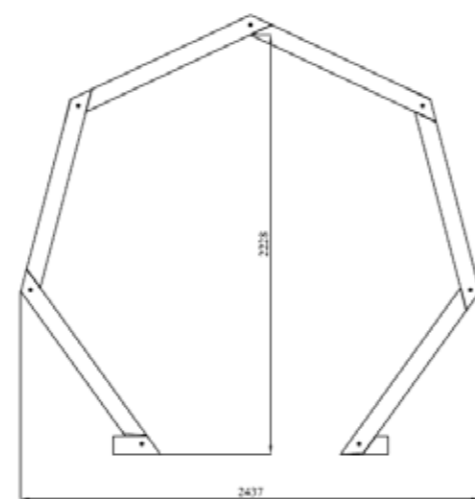

HEXAGON MOON GATE

This unique and stylish gate is inspired by the traditional Eastern style moon gate, but with a modern twist. The hexagonal shape adds a touch of whimsy and sophistication, while the open design allows for a seamless transition between different areas of your garden.

Pressure Treated Green:

H223.4 x W239.5 x D27 cm | HEXMG

Weight: 39kg



CAROUSEL PERGOLA

A timeless garden structure. The curves of the top beam reflect the natural shapes in your garden, whilst providing an effective frame for a garden feature beneath.

Pressure Treated Green:

H280 x W363.5 x D363.5 cm | PKITCRAG

Posts: 9.5cm sq.

Internal diameter: 270cm

Weight: 134kg

Outer diameter: 360cm

Overhang: 40cm (approx)

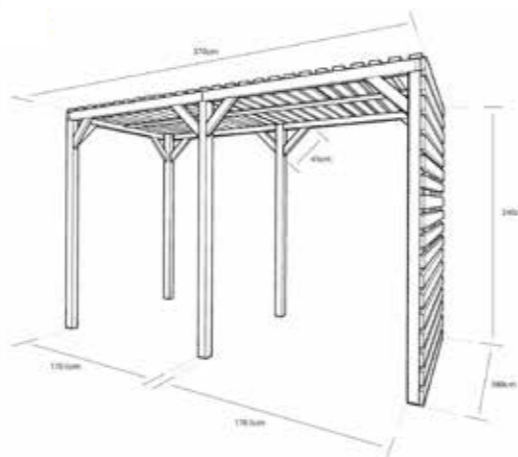

CONTEMPORARY URBAN PERGOLA

This modern pergola is great for dining and entertaining, the back screen is ideal for hanging plants as well as providing a wind shield.

Pressure Treated Green:

H244 x W370 x D180 cm | CONURBP

Posts: 9cm sq.

Screen slat width: 9.5cm

Weight: 237.5kg

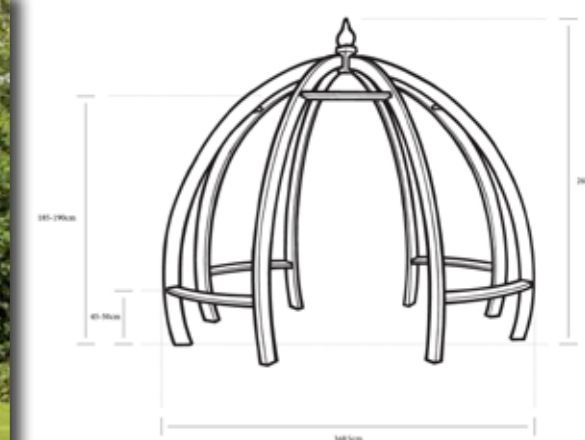

APOLLO PERGOLA

A distinctively designed dome shaped structure that will give your garden a contemporary feel. As a centrepiece, it can provide a focal point for fountains, ornaments or a picnic area.

Pressure Treated Green:

H261 x W348.5 x D344.5 cm | APOLPERG

Weight: 100kg

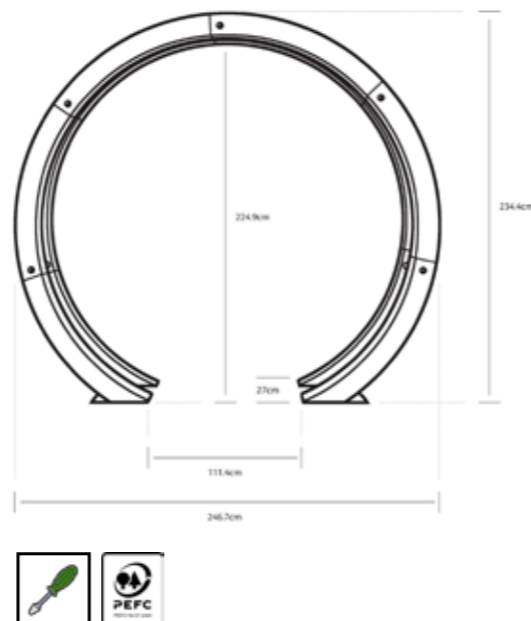

FREE STANDING FLOWER CIRCLE

The contemporary Flower Circle is constructed using two rounded beams closely connected with stainless steel rods to create a sculptural archway.

Pressure Treated Green:

H234.5 x W247 x D27 cm | FSFCIRCSPK (with ground spikes)

H234.5 x W247 x D27 cm | FSFCIRCBDA (with bolt downs)

Pre-treated Charcoal Black:

H234.5 x W247 x D27 cm | FSFCIRCBLSPK (with ground spikes)

H234.5 x W247 x D27 cm | FCIRCBLBDA (with bolt downs)

Timber thickness: 9.5cm x 4.4cm
Weight: 42kg

As featured on the Alan Titchmarsh ITV show 'Love Your Garden'

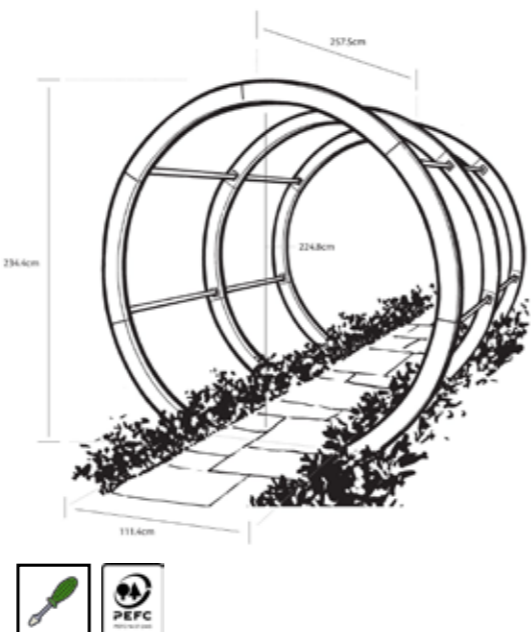

FLOWER WALK

An eye-catching and contemporary design which gives an attractive outline to your garden path.

Pressure Treated Green:

H234.5 x W250 x D257.5 cm | FLWCCL (No Fixings)

H234.5 x W250 x D257.5 cm | FLWCCLB (Bolt Down Fixings)

H234.5 x W250 x D257.5 cm | FLWCCLC (Ground Spike Fixings)

Gap between circles: 120cm

Weight: 67kg

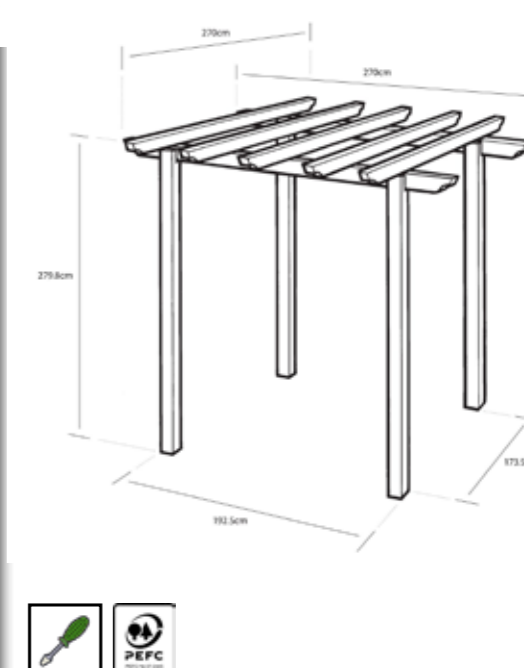

TRADITIONAL PERGOLA

Ideal for use on a lawn or patio area. Great for growing climbing plants and roses.

Pressure Treated Green:

H280 x W270 x D270 cm | PKTRADA

Posts: 9.5 x 9.5cm

Weight: 129kg

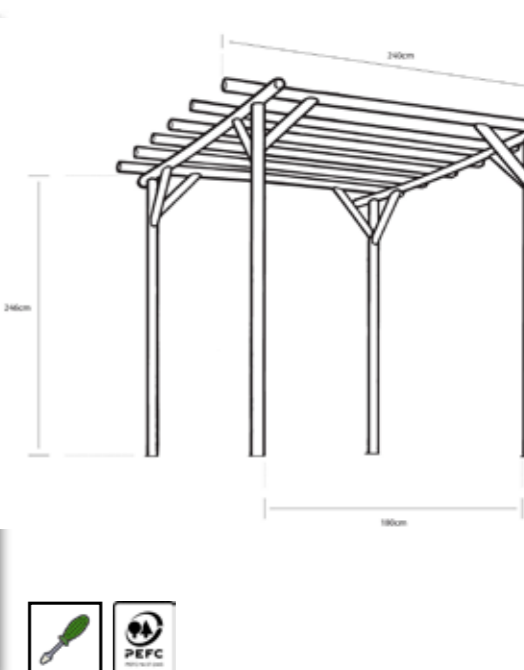

RUSTIC ROSE PERGOLA

Ideal for use on a lawn or patio area. Great for growing climbing plants and roses.

Pressure Treated Green:

H252 x W240 x D240 cm | RRPERG

Posts: 240cm height

Weight: 70kg



CONTEMPORARY ARBOUR

This striking arbour combines modern straight lines and a classic curved roof, created using quality finger joints.

Pressure Treated Green:

H220 x W150 x D70 cm | CONTARB

Pre-treated Charcoal Black:

H220 x W150 x D70 cm | CONTARBCB

Weight: 90kg

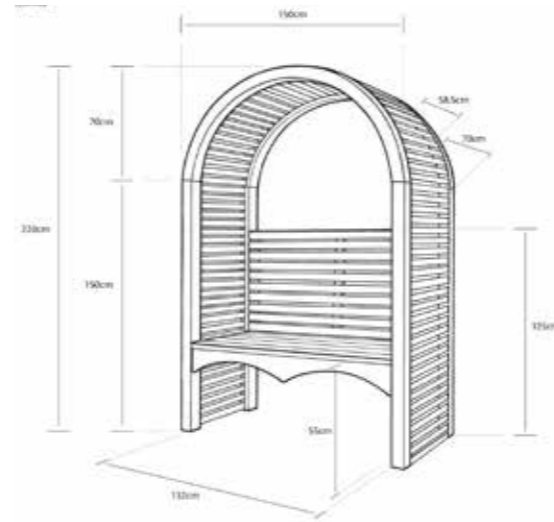

CONTEMPORARY ARCH

The chunky arched top, posts and slats are planed, rounded and chamfered for a modern look.

Pressure Treated Green:

H260 x W150 x D70 cm | CONTARCH

Weight: 74kg

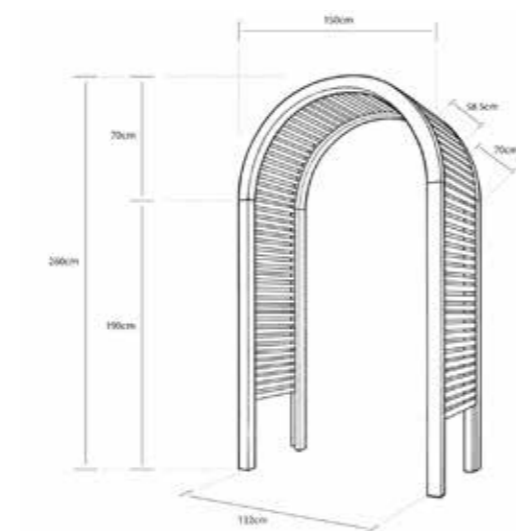

ELITE GRANVILLE ARCH

Classic look, strong and robust. This arch is suitable as a free standing structure on either a path or garden space. The square trellis sides are ideal for climbing plants.

Pressure Treated Green:

H273 x W125 x D60 cm | EGA

Posts: 7cm sq.
Will fit paths: Up to 105cm wide
Weight: 44kg

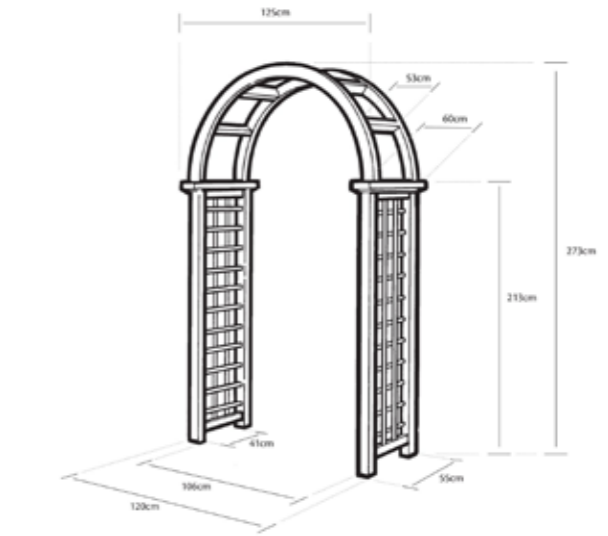

ELITE GARDEN ARCH

A subtle arch creates an attractive garden structure. Square trellis sides are complemented by a curved top.

Pressure Treated Green:

H254 x W100 x D44.5 cm | ELITEARCH

Posts: 4.5cm sq.
Will fit paths: Up to 90cm wide
Weight: 20kg

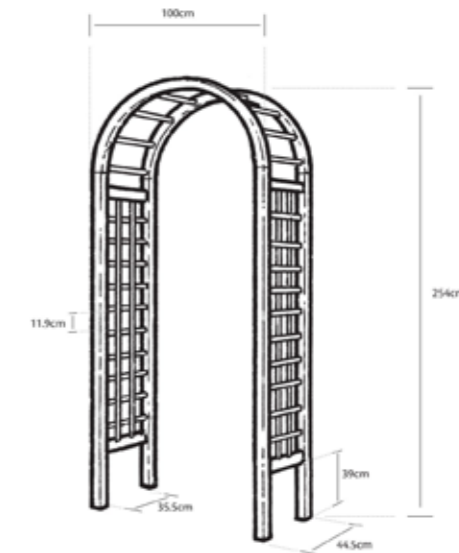

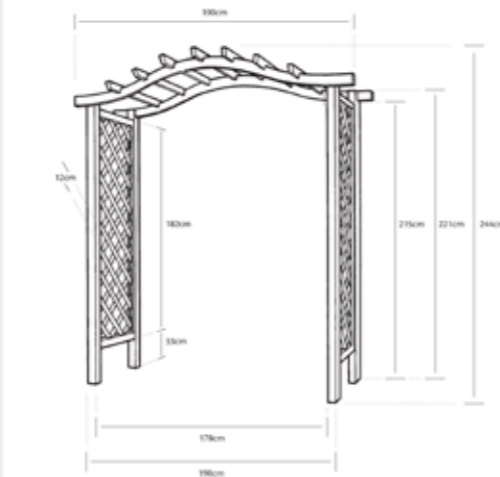

ELITE PORTICO ARCH

Unique design with a curved roof and lattice style trellis side panels - a stylish solution for any garden space. The space for hanging baskets will enhance a path, or it can be used as a standalone feature.

Pressure Treated Green:
H244 x W210 x D112.5 cm | ELITEPORTE

Posts: 6cm sq.
Will fit paths: up to 180cm wide
Holes in trellis: 12cm
Weight: 55kg

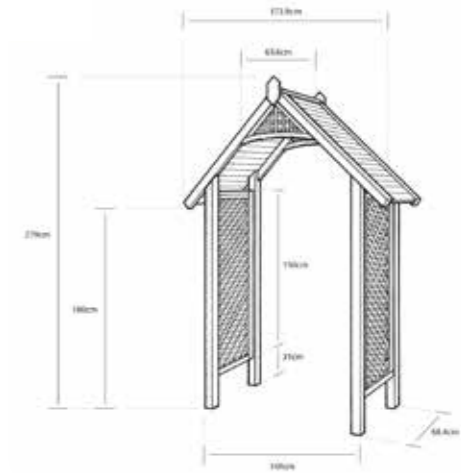

VALENCIA ARCH

A strong and robust arch with diamond trellis sides and a slatted roof finished with pointed finials. This classic design is ideal for accentuating any garden path.

Pressure Treated Green:
H279 x W174 x D72 cm | VALARCH

Weight: 64kg

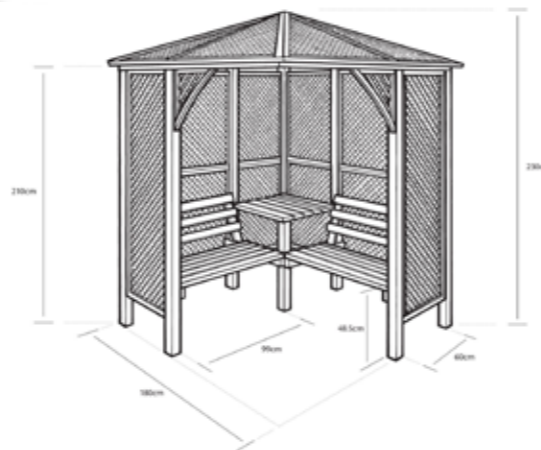

VALENCIA CORNER ARBOUR

A structure ideal for creating a sheltered dining area or a relaxing seating area. The lattice trellis design creates a truly classic structure.

Pressure Treated Green:
H230 x W200 x D200 cm | VALCORARB

Lattice Dimension: 20mm x 8mm
Trellis Holes: 40mm sq.5
Weight: 214kg

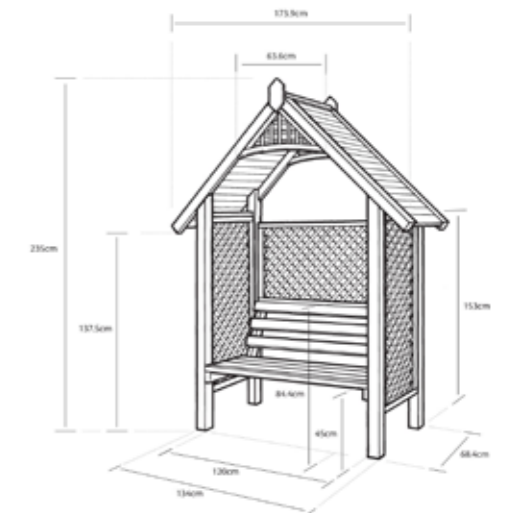

VALENCIA ARBOUR

This classic arbour is designed with diamond trellis sides and back to support climbing plants. The slatted roof provides extra protection from the sun you to sit back and relax.

Pressure Treated Green:
H235 x W174 x D68.5 cm | VALARB

Weight: 86kg

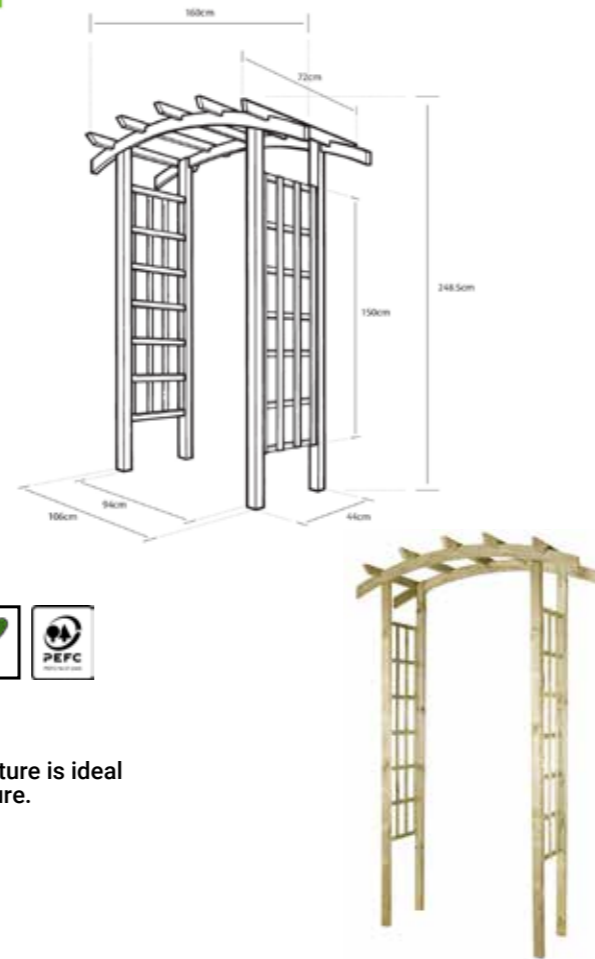

BOW TOP ARCH

Decorative square trellis sides to enhance any garden space. The structure is ideal for creating an impressionable pathway or as a decorative garden feature.

Pressure Treated Green:
H248.5 x W160 x D72 cm | BTA
Weight: 33.5kg

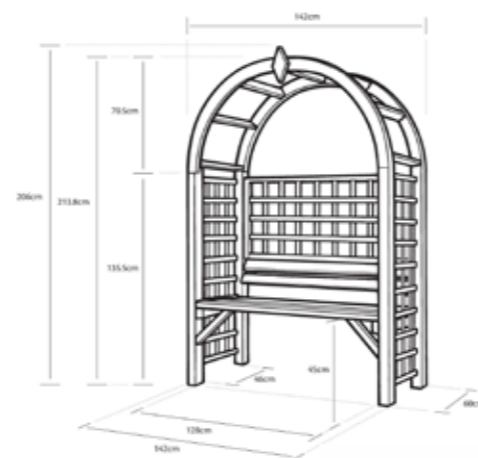

MONTEBELLO ARBOUR

A large and inviting structure with an attractive bow shaped roof. This versatile structure is ideal for both contemporary and traditional gardens alike.

Pressure Treated Green:
H213.8 x W142 x D60 cm | MONTARB
Weight: 60kg

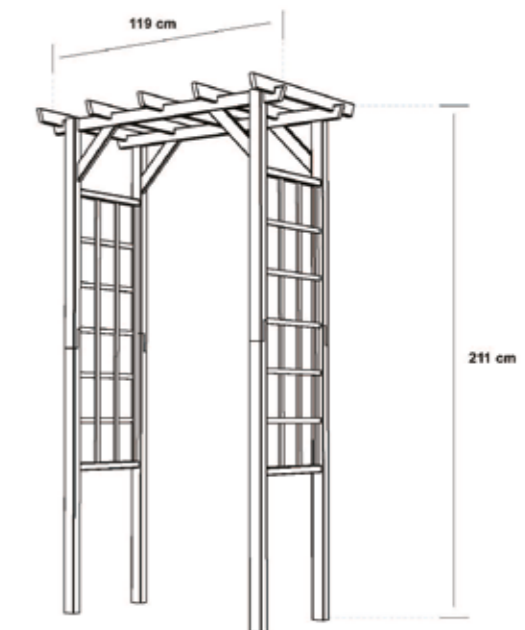

TENERIFE ARCH

This stylish archway is perfect for defining pathways or providing support for climbing plants. Supplied flat-packed small enough to fit into your car, making it easy to buy and take home the same day.

Pressure Treated Green:
H211 x W119 x D70 cm | ETTARCH
Pack Size: 10

This product is delivered 'Flat-Packed' and designed to be easily transported in the boot of a car.

Pallet Dimensions:
H120 x W50 x D10cm
Weight: 23.7kg



How to prep the area for a Pergola

Pergolas can be used in the garden to create a passageway or to frame a seating area.

Grange offers a wide range of project kits as well as individual components to allow the creation of your own personal vision.

A basic pergola project is explained here, however, the basic procedures will be the same whatever design you choose.

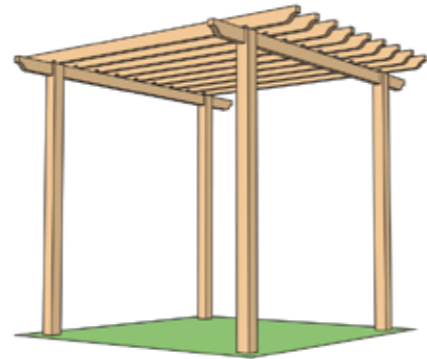

- Tools required:**
- Tape measure
 - Power drill
 - Spirit level
 - Hammer
 - Sledge Hammer

PREPARATION OF THE AREA

Consider the location carefully before proceeding. Where will the sun be at the time of day you use it? What access is required?

Determine the footprint required for the pergola proposed. Ensure the area is clear and mark out the positions for the posts.

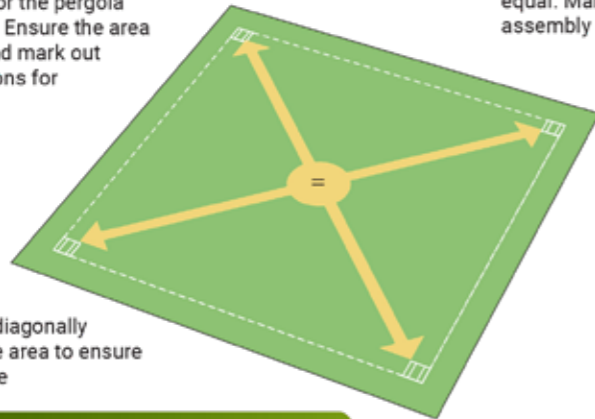

Measure diagonally across the area to ensure it is square

For a domed pergola project, the best method for determining the positions of the posts is to pre-assemble the roof and use this as a template for the posts.

Check the dimension between the roof rafter ends and ensure that they are equal. Mark the position on the ground for each post. Remove the roof assembly and prepare the holes for the posts.

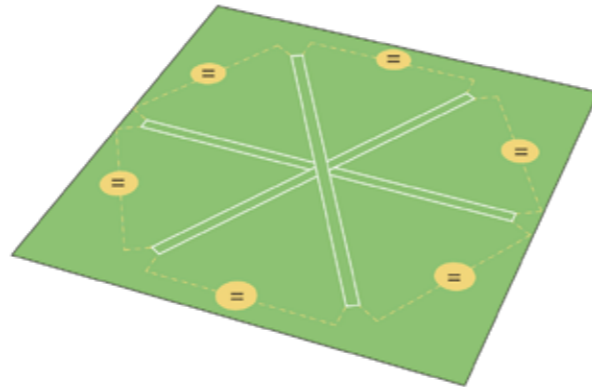

INSTALLING THE POSTS

Posts are common to all pergola designs and how you install these will depend on the ground conditions.

For solid ground such as a patio or a concrete hardstand area, install your posts using Metpost Pergola Bolt Downs fixed with Metpost Anchor Bolts.

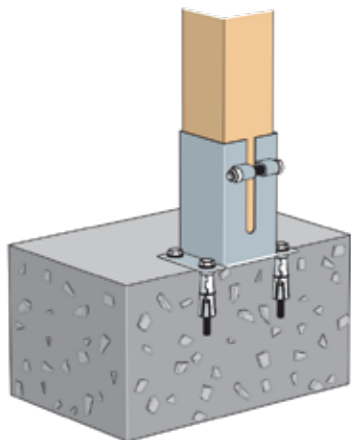

For soft ground you have a choice of either installing the posts directly into the ground using MetCrete post fixing concrete (this method will require buying longer posts) or, use Metpost Pergola Spikes.

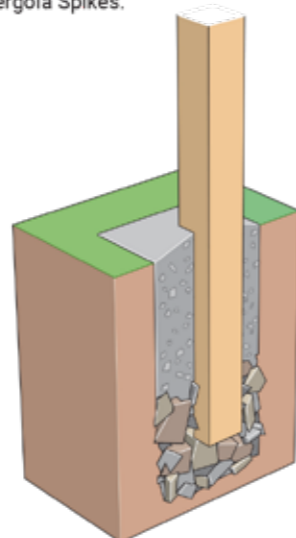

Whichever method is chosen, make regular checks with a spirit level, during the installation, to ensure that the posts remain vertical.

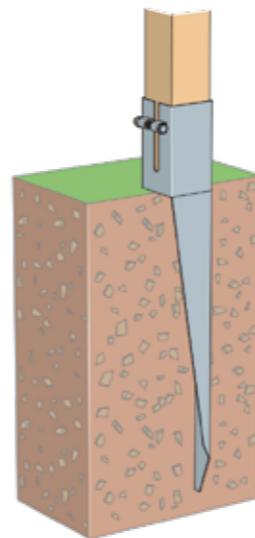

6X4FT GARDEN SHED

The 6x4ft wooden shed features a classic 'barn door' entryway to make storing and accessing your larger items easier. The windowless design means the contents of your shed stay private and away from prying eyes, the floor and roof are made using tongue and groove timber boards.

Pressure Treated Green:

H214 x W196 x D125 cm | GWS6FT

Supplied as singles

Weight: 188kg

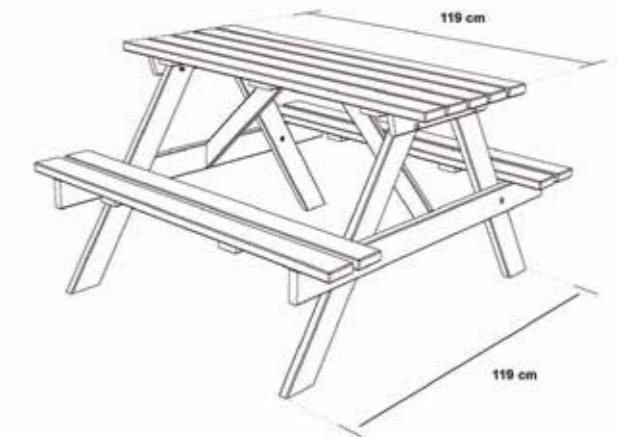

OASIS PICNIC TABLE

A compact picnic table which offers a great place to entertain and enjoy drinks or meals in your garden, plus this table is designed to be easy to transport at point of sale.

Pressure Treated Green:

H71.8 x W119 x D119 cm | ETTPTABLE

Pack Size: 1

This product is delivered 'Flat-Packed' and designed to be easily transported in the boot of a car.

Pallet Dimensions:
H121 x W51.5 x D12cm

Weight: 35kg



URBAN SCREEN SQUARE PLANTER

An attractive square planter with an integrated, stylish trellis feature at the back which is perfect for climbing plants or vegetables.

Pressure Treated Green:

H118 x W40 x D40 cm | USPS

Pack Size: 10

Weight: 15kg



TALL CONTEMPORARY PLANTER

A modern planter designed to complement the Contemporary Vogue Fence Panel and structures.

Pressure Treated Green:

H72 x W40 x D40 cm | CONPLTL

Supplied as singles

Weight: 10.5kg



RECTANGULAR CONTEMPORARY PLANTER

Perfect as a showpiece on a patio or decking area. Designed to match the Contemporary Collection.

Pressure Treated Green:

H33 x W120 x D50 cm | CONPLREC

Supplied as singles

Weight: 13.5kg



SQUARE CONTEMPORARY PLANTER

This robust square planter is a perfect addition to the Grange Contemporary Vogue Fence Panel and structures range.

Pressure Treated Green:

H50 x W50 x D50 cm | CONPLSQ

Pretreated Charcoal Black:

H50 x W50 x D50 cm | CONPLSQCB

Supplied as singles

Weight: 11kg





ELITE RECTANGULAR PLANTER

Robust planter ideal for planting displays, or growing vegetables. The smooth timber is planed and heavy duty.

Pressure Treated Green:
 H30 x W120 x D40 cm | ERP
 Supplied as singles
 Weight: 23.3kg



ELITE SQUARE MEDIUM PLANTER

Ideal for creating a modern planting display.

Pressure Treated Green:
 H30 x W40 x D40 cm | ESMP
 Supplied as singles
 Weight: 10.7kg



ELITE SQUARE LARGE PLANTER

Heavy duty large square planter which is ideal for planting displays in your garden.

Pressure Treated Green:
 H36 x W50 x D50 cm | ESLP
 Supplied as singles
 Weight: 21kg



HEXA PLANTER

Perfect as a showpiece on a patio or decking area. Designed to match the Contemporary Collection.

Pressure Treated Green:
 H30.5 x W45 x D39 cm | HEXMPLMED
 Supplied as singles



TRELLIS OBELISK

Perfect for growing runner beans or other climbing plants.

Pressure Treated Green:

H179.8 x W53 x D53 cm | TRELOB

Supplied as singles

Weight: 7.4kg



LOG EDGING ROLL

Log Roll Edging is ideal for border edges or for creating small boundary fencing. This product is flexible to suit all borders.

Pre-treated Grey:

H17 x W120 x D1.4 cm | GRLE120

Pallet quantity: 144



SAWN NEW RAILWAY SLEEPER

A large piece of timber in the design of a classic railway sleeper. Use for garden edging and creating steps, raised terraces or beds.

Pressure Treated Green:

H20 x W120 x D12 cm | SSS12

Pallet quantity: 24



HORIZONTAL LOG BORDER EDGING

This grey log border edging makes it easy to create decorative borders in your back garden; perfect for enhancing special features such as flower beds or paths. This product is rigid and is not suitable for round edges.

Pre-treated Grey:

H15 x W100 x D2.4cm | HLB100GREY

Pallet quantity: 240



LANDSCAPE POLE

Machine rounded timber pole great for supporting plants and trees or for creating special features for landscaping projects.

Pressure Treated Green:

H75 x DIA8 cm | LP26G

H120 x DIA8 cm | LP4G

H160 x DIA8 cm | LP56G

Pack size: 20



DAHLIA STAKE

Dahlia stakes are square cut pressure treated pieces of timber which are best used to support your plants or trees.

Pressure Treated Green:

H120 x W2.5 x D2.5 cm (*50) | GS4G

H150 x W3.1 x D3 cm (*50) | GS531G

H180 x W3.1 x D3 cm (*50) | GS631G

H180 x W2.5 x D2.5 cm (*50) | GS6G

*Banded quantities



TREE POLE

Machine rounded timber ideal to use as a plant or tree support.

Pressure Treated Green:

H150 x DIA4 cm | RPOLE540G

H180 x DIA4 cm | RPOLE640G

Pack size: 12

H180 x DIA6 cm | RPOLE6G

H240 x DIA6 cm | RPOLE8G

Pack size: 20



FIXING STAKE

The fixing spike can be used in numerous garden applications from securing log edging to defining building plots.

Pressure Treated Green:

H45 x W3.1 x D3 cm | FIX32G

Pack size: 100





LOG EDGING ROLL

The Log Roll Edging is ideal for border edges or for creating small boundary fencing.

Pressure Treated Green:

H15 x W180 x D3 cm | GLE150P

Pallet quantity: 72

H22.5 x W180 x D3 cm | GLE225P

Pallet quantity: 48

H30 x W180 x D3 cm | GLE300P

Pallet quantity: 36



HORIZONTAL LOG BOARD

The Horizontal Log Board is ideal for border edges or for creating small boundary fencing.

Pressure Treated Green:

H14 x W100 x D7 cm | HLOGBRD

Pack size: 120



LANDSCAPE POLE

The green log edging board makes it easy to create decorative borders in your back garden; perfect for enhancing special features such as flower beds or paths.

Pressure Treated Green:

H15 x W100 x D4.5 cm | GLEB150P

Pallet quantity: 84

H30 x W100 x D4.5 cm | GLEB300P

Pallet quantity: 52



HORIZONTAL LOG BORDER EDGING

The Horizontal Log Border Edging is ideal for border edges or for creating small boundary fencing.

Pressure Treated Green:

H30 x W80 x D4.6cm | HLB80

Pallet quantity: 80



Harry's guide to landscaping

PROJECT 1 - BUILD A RAISED BED

Using stakes and a string line, mark out the area of your raised bed. Dig out area of bed to depth of 50 - 75mm.

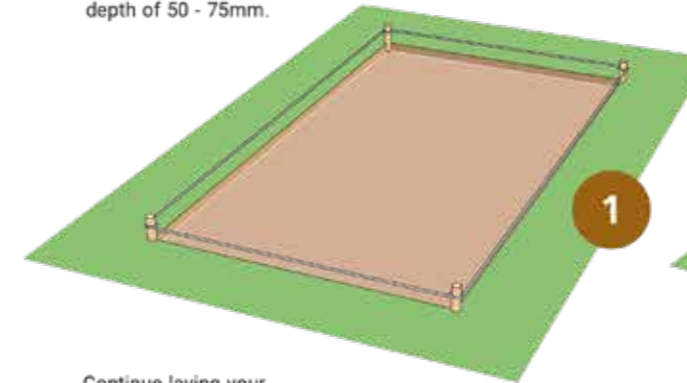

Start laying out the bottom course of sleepers, fixing them to the ground with metal rods. Fit Grange Angle Landscape Connectors at each corner.

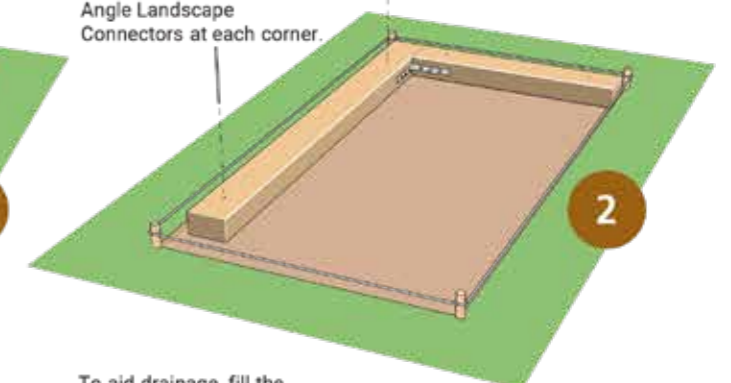

Continue laying your sleepers using the coursing method described above. Fit Grange Angle Landscape Connectors or Straight Landscape Connectors as required.

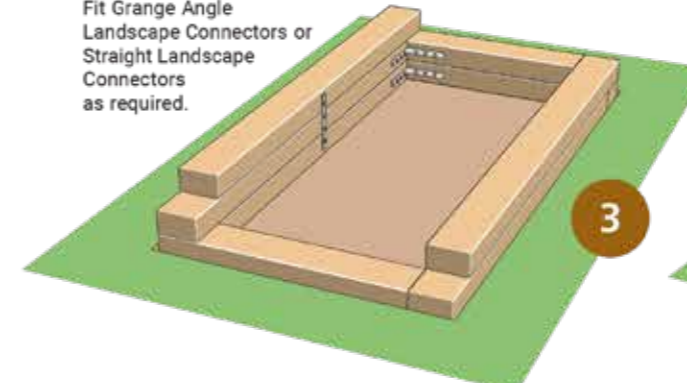

To aid drainage, fill the base with hardcore to a depth of 50 - 75mm. Then fill the bed with compost or a soil/compost mix.

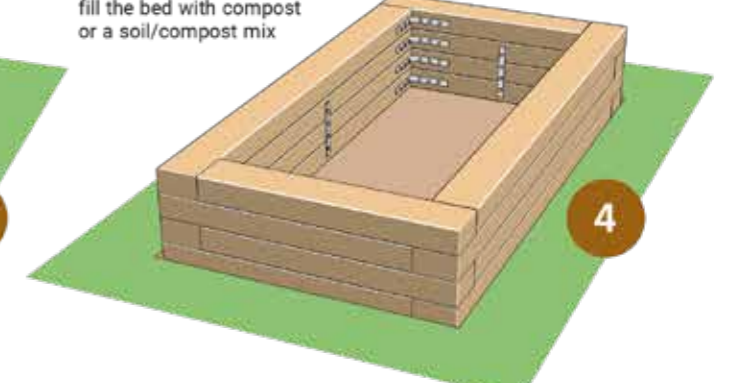

PROJECT 2 - BUILD A RETAINING WALL

Sleepers may be used vertically or horizontally when building a retaining wall. Horizontally laid sleepers are recommended for low level walls.

It is vital to use the coursing method described above in order to strengthen your wall and maintain its integrity.

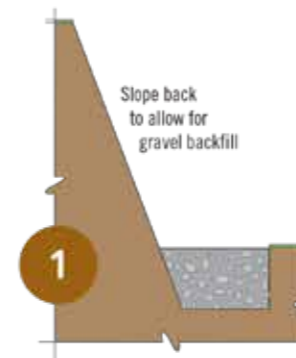
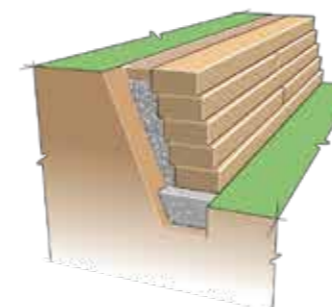

Prepare a 50mm deep footing for your wall using a sand and cement mortar mix.

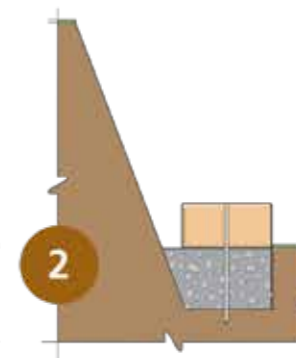

Lay the first course of sleepers and fix by inserting metal rods through pre-drilled holes into the footings as shown above.

Continue building to the top. Maintain the 25mm step-back and ensure all sleepers are firmly fixed to the ones below.

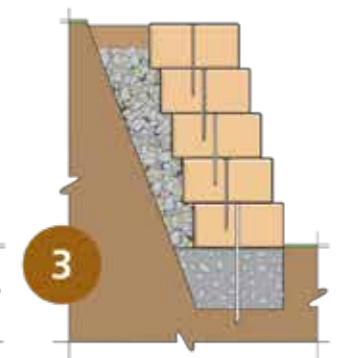

Lay the second course on top of the first, setting it back 25mm from the front. Fix firmly to the lower course using screws.

Backfill with gravel to aid drainage. Top off with a layer of soil.



COMPOSTER MEDIUM

This generously sized wooden Garden Composter is essential for every garden, providing insulation, allowing the compost to breathe.

Pressure Treated Green:
H71.5 x W93 x D93 cm | CM930
(Capacity: 450 litres)
Pallet quantity: 12



COMPOSTER LARGE

This large wooden Garden Composter is essential for every garden, providing insulation, allowing the compost to breathe.

Pressure Treated Green:
H71.5 x W113 x D113 cm | CM1130
(Capacity: 700 litres)
Pallet quantity: 12



HEAVY DUTY POST CAP

As well as adding a decorative feel this also adds extra protection to your post.

Pressure Treated Brown:
H2 x W12 x D12 cm | PCHD55
Pressure Treated Green:
H2 x W12 x D12 cm | PCHD55G
Pack size: 50



FLAT POST CAP

This post cap adds a decorative feel to a number of fence panels.

Pressure Treated Brown:
H2 x W10 x D10 cm | PC22
Pressure Treated Green:
H2 x W10 x D10 cm | PC22G
Pack size: 100



How to build a composter

Using a composter to make your own compost saves time and money and, if you want to 'grow your own', there's no better place to start. Compost improves low quality soils by adding organic matter and nutrients, and plants grown in good soil are healthier with a greater resistance to diseases and insects.

ASSEMBLING YOUR COMPOSTER

Place two of the smaller half-slats on the soil as shown. Inset one of the full slats into the cutouts at either end to form a square base.

Continue adding full slats to the assembly, building up the sides.

Add a layer of straw or twigs 100mm thick to aid circulation.

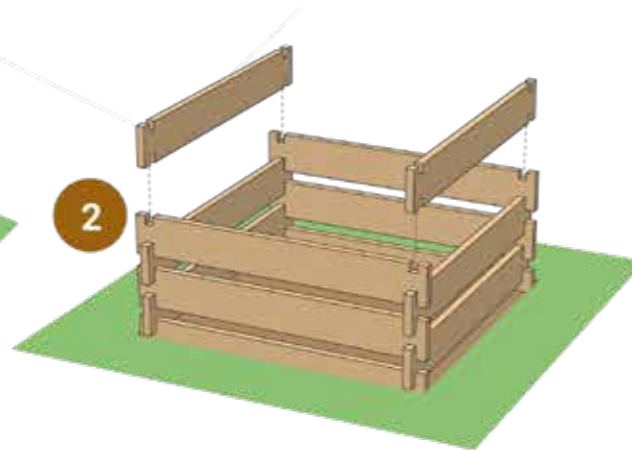
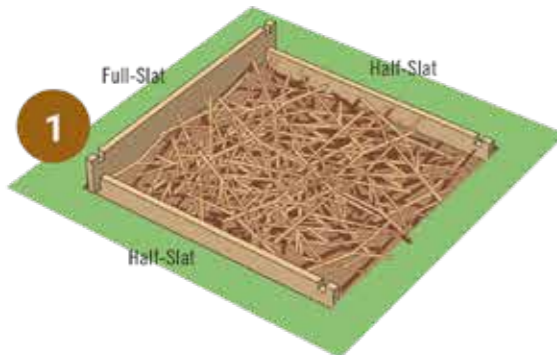

Finally, put the two remaining half-slats into position to complete the assembly.

A composter relies on heat generation to create compost and moisture is also vital to this process. It is important therefore to retain heat, prevent the compost from drying out but also to prevent it from becoming water-logged. A composter cover will help prevent all of these conditions.

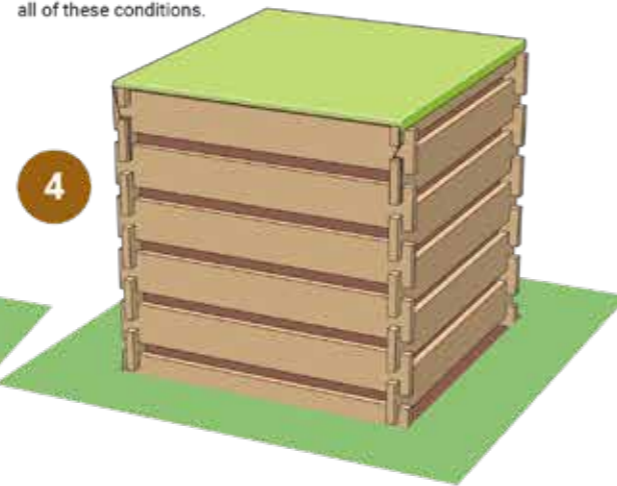
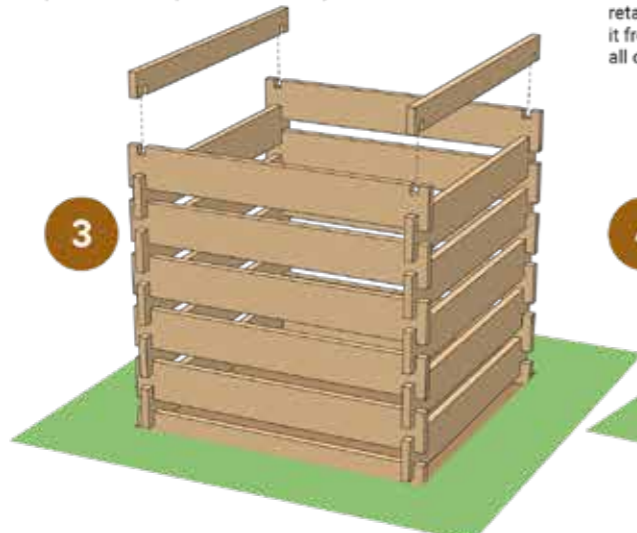

TIMBER GRAVEL BOARD

Ideal to use with traditional styles of fencing.

Pressure Treated Brown:
H15 x W183 x D2 cm | TGB6
Pack size: 49



FEATHEREDGE CAPPING RAIL

Provides a neat top to the featheredge panel system.

Pressure Treated Green:
H183 x W5 x D2.5 cm | CAPNGFE
Pack size: 10



6" TRELLIS CAPPING RAIL

Provides a neat top to your trellis.
Pressure Treated Golden Brown:
H4 x W183 x D2.5 cm | CAPPINGS
Pack size: 10



ELITE PANEL SIDE STRIP

Use the side strip to extend the width of fence panels to 183 cm for a perfect fit with current posts and gravel boards.

Pressure Treated Green:
H180 x W4 x D1.5 cm | EPSS
Pack size: 10





BALL FINIAL POST CAP

This post cap adds a decorative feel to a number of fence panels.

Dipped Brown:
H13.5 x W10 x D10 cm | BALLPC
Pack size: 20



ELITE BALL FINIAL POST CAP

Pressure Treated Green:
H10 x W10 x D10 cm | EBALLPCG
Pack size: 20

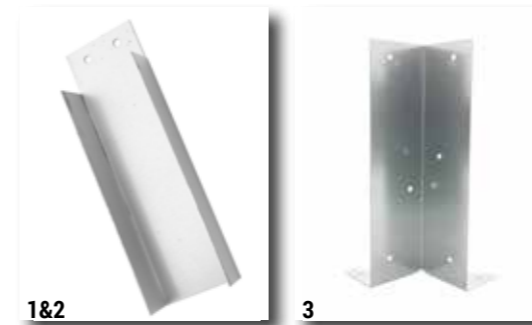

GRAVEL BOARD CLIPS & ARRIS RAIL BRACKETS

1. Gravel Board Clip 25 mm | 1112
Pack size: 50
2. Gravel Board Clip 50 mm | 1113
Pack size: 50
3. Arris Rail Bracket 220 mm | 11131
Pack size: 50

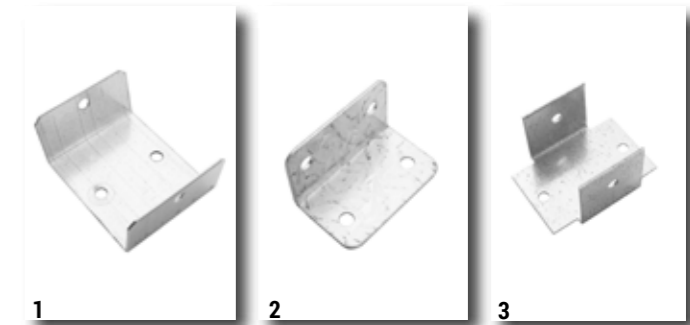

METPOST FIXING CLIPS

1. U-shaped clip 41 mm | 1108
 2. U-shaped clip 46 mm | 1109
 3. U-shaped clip 52 mm | 1110
- Items 1-3 - Pack size: 250
4. L-shaped clip 50 mm x 25 mm x 25 mm | 1111
Pack size: 200
 5. U-shaped trellis clip 32 mm | 1114
Pack size: 250



HOOK & BAND HINGES & RING HANDLE

Pack contains:
2x CHB Hinges 10", 2 x Hook Plates, 1x Latch Set,
Screws | CHBGKIT
Pack size: 10



HINGE & AUTO LATCH FITTINGS KIT

Pack contains:
2x T Hinges 10", 1x Auto Latch, Screws | THKIT
Pack size: 10



DRIVE TOOLS

Facilitates driving post supports into the ground.

1. For 75 mm Box 58 x 180 mm | 332
Pack size: 10
2. For 100 mm Box 78 x 190 mm | 442
Pack size: 10



METPINS

Log Roll Pin (Galvanised)
25 x 450 mm | 702
Pack size: 50



'SUFFOLK' LATCH & HINGE FITTINGS KIT

Pack contains:
2x T Hinges 10", 1x 'Suffolk' Latch, Screws | LHKIT
Pack size: 10



CURVED HINGE FITTINGS KIT

Available for both right hanging or left hanging gates.

Pack contains:
1x Top Curve Hinge, 1x Bottom Hinge, Screws | CVHRKIT (RHS) / CVHLKIT (LHS)
Pack size: 10



ANCHOR BOLTS

Extra Bolts : M8 x 65 mm long in packs of 4 | ANCBOLT
Pack size: 10 (4 bolts in each pack)



POST EXTENDER

Raises the height of an existing post.
75 x 180 mm | 162
Pack size: 10
100 x 180 mm | 1644
Pack size: 10

GRANGE HAVE A RANGE OF MATERIALS AND DOWNLOADABLE CONTENT AVAILABLE FOR STOCKISTS TO HELP MERCHANDISE AND MARKET OUR PRODUCTS. IF YOU WOULD LIKE A COPY OF OUR MARKETING PACK PLEASE CONTACT YOUR LOCAL SALES REPRESENTATIVE OR OUR CUSTOMER SERVICE TEAM WHO WILL BE HAPPY TO HELP YOU.



STEP DISPLAY KITS

A kit containing the stand, POS signage and A4 individual product cards (where applicable).

GSLSDSET | Step display set with fixed GSL Ranged stock line-up

Panels included: 1x GSL, 1x GSCBN, 1x GSFE

FLEXSDSET | Step display set with flexible stock line-up of fence panels

FLEXSDSETG | Step display set with flexible stock line-up of gates

Please contact your area manager for advice on which products are suitable for your branch.



METPOST DISPLAY STAND

A kit containing the stand, POS signage and A4 individual product cards (where applicable).

MPMERCHB | Metpost Stand
H153 x W120 x D66cm

Stock profile can be customised to customer requirements.

Please speak to your Area Sales Manager or Customer Support for further details.

BANNER

Promotional banners, please speak to your local area sales manager for availability.



SRS DISPLAY KIT

A kit containing the stand & POS signage.

SRS09CKIT | Triple Bay Display Rack

Please contact your area manager for advice on whether this product is suitable for your branch.

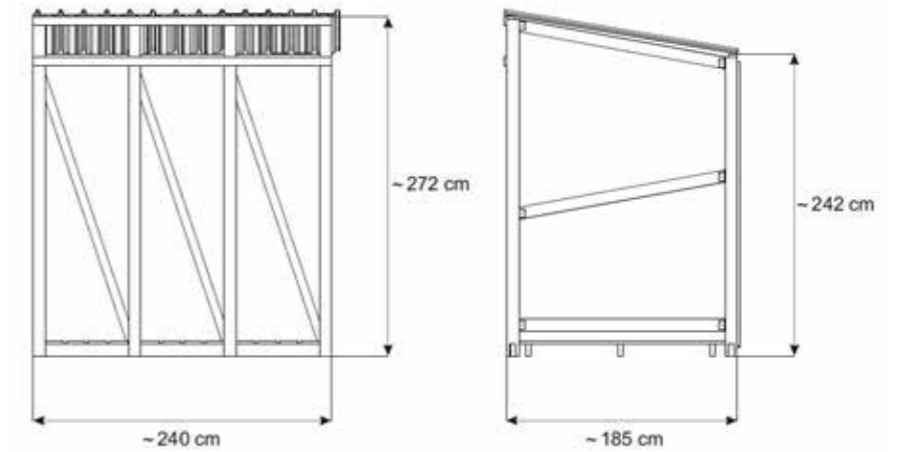

MERCHANDISING TEAM

In addition to our merchandising options, Grange can support your business with the help of our Merchandising Team. Travelling the entirety of England, Scotland & Wales; the team are available for installing SRS racking, step displays or even custom product display areas for your branch.



Grange operates its own fleet of HGV's along with 3rd party haulage partners, allowing us to flex delivery capacity seasonally with demand.

DID YOU KNOW ALL OF OUR TRADITIONAL PANELS ARE AVAILABLE IN VERTICAL PACKAGING AS WELL AS THE USUAL HORIZONTAL STYLE?

Vertical packaging is a great way to save space in your yard thanks to its reduced footprint, there are no equipment rental charges for the pallet shoes, any packaging is disposable in branch once the pallet is empty, plus the added bonus of the elimination of water pooling on the panels. The vertical packaging also looks better as your customers can see the panel upright, on display helping them visualise how they would see the panel in their garden.



Lap Vertical Packaging User & Safety Guide

PREPARING THE PACK FOR USE

1		<p>ENSURE TOP GREEN BANDING IS IN PLACE AND UNDAMAGED. UNDER NO CIRCUMSTANCES SHOULD THIS BANDING BE CUT WHILST PANELS ARE IN-SITU IN THE VERTICAL PACKAGING. ALWAYS START UNPACKING FROM THE FRONT.</p>
2		<p>THE WHITE STRIP SECURES PANELS TOGETHER, DO NOT REMOVE THIS UNTIL A PANEL IS REQUIRED.</p>

USING THE PACK FOR SALE

<p>3</p> <p>DO NOT REMOVE HORIZONTAL TIMBER STRIP FROM THE TOP REAR OF THE PACKAGING FRAME.</p>	<p>4</p> <p>REMOVE GREEN BANDING FROM YOUR VERTICAL PACKAGING, DO NOT REMOVE THE GREEN BANDING FROM THE TOP (SEE POINT 1). DO NOT REMOVE THE WHITE BANDING.</p>
<p>5</p> <p>WHEN YOU REQUIRE A PANEL, PULL ON THE STRIP ON EITHER SIDE OF THE PANEL TO RELEASE IT.</p>	<p>6</p> <p>PLACE FOOT UNDER THE BOTTOM OF THE PANEL, USING A CAREFUL LIFTING MOTION. WHILST LIFTING, GENTLY MOVE YOUR FOOT TOWARDS YOU, ANGLING THE BASE OF THE PANEL AWAY FROM THE PACKAGING.</p>
<p>7</p> <p>ONCE THE BASE OF THE PANEL IS CLEAR, LOWER TO THE GROUND. YOUR PANEL SHOULD NOW BE FREE TO MOVE AWAY FROM THE PACKAGING. REPEAT UNTIL EMPTY.</p>	<p>8</p> <p>ONCE YOU HAVE FINISHED WITH YOUR VERTICAL PACKAGING SIMPLY REMOVE SCREWS AND PLACE INTO FLAT PACK.</p>

PRESSURE TREATMENT DISCLAIMER

We are committed to using a pressure treatment method across our full range of timber products to provide a superior approach to wood preservation and eliminate the need for costly and time-consuming maintenance. Should the pressure treated wood be cut, drilled or notched, we recommend that a cut end treatment be applied to ensure the effectiveness of the treatment. Paints, wood stains and water repellent can be applied however we recommend you closely follow the manufacturer's instructions.

TIMBER TREATMENTS

IMPRALIT KDS
Pressure treated green

IMPRALIT KDS +brown paste

IMPRALIT TSK +farb paste pinia
Pressure treated golden brown

IMPRALAN FARBKONZENTRAT SCHWARZ
Pre-treated Grey

CONDITIONS OF GUARANTEE

a) should the pressure treated wood be cut, drilled or notched, a cut end treatment must be applied to ensure the effectiveness of the treatment. (Note: cutting the wood is considered a modification which will render the guarantee null and void)

b) Paints, wood stains and water repellent can be applied - however, we recommend you closely follow the manufacturer's instructions.

c) Any product modification will render the guarantee null and void.

d) The guarantee covers the cost of replacement goods only.

e) Grange cannot be held liable for any damages or injuries of any kind resulting from incorrect use, assembly or siting of the products. Where supplied, instructions and directives should be followed carefully.

f) Retain proof of purchase in order to claim on this guarantee.

These conditions do not affect your statutory rights.

Full T&C's can be found on our website
www.grangefencing.co.uk

COPYRIGHT

© Copyright 2023 Grange Fencing LTD. All rights reserved. In line with the company's policy of continuous improvement, the right is reserved to change and improve product design without prior notice. All dimensions quoted are approximate and subject to change.

All products and related emblems features are trademarks of Grange Fencing LTD.



CARBON BALANCED PAPER

www.carbonbalancedpaper.com
CBP035983

This brochure is printed on Carbon Balanced Paper. This initiative, run by the World Land Trust (WLT), provides a simple, valid and measurable way to offset the carbon emissions generated by paper and printed communications. Rather than generic carbon offsetting, WLT's programme conserves ecologically important forests under imminent threat of clearance - standing forests that lock in carbon which would otherwise be released, and continue to absorb carbon dioxide throughout their lifetime. The programme considers the average carbon emissions related to the manufacture of paper from cradle to gate, making it a transparent and credible solution. Since its launch in 2011, over 3,000 brands and organisations have taken positive action by choosing Carbon Balanced Paper, and we are proud to be among them.

UNDERSTANDING CHARACTERISTICS OF TIMBER

It must be remembered that timber is a natural product and will be subject to movement and weathering as it seasons. It is not uncommon for small splits to occur (called shakes) in timber when drying, and for warping when timber is allowed to dry too rapidly. These will normally go back when humidity rises. This is nature at work and should not be considered as a fault. Acceptable limits are defined in the relevant British Standards. For further information on characteristics on timber, visit our website

www.grangefencing.co.uk

TERMS AND CONDITIONS

Disclaimer

Grange cannot be held liable for any damages or injuries of any kind relating from the incorrect use, assembly or siting of the products described in this brochure. All dimensions are approximate as the characteristics of timber can alter sizing. We advise for you to wait until you have received and erected your product before preparing the installation of your footprint area as dimensions may have variations due to improved product specification and development which is subject to change without notice.

A helpful order and delivery guide for our trade customers in the UK and Ireland

AREA 1

ORDER MONDAY
DELIVERY THURS/FRI

B BL BN CB CH
CM CO CT CV CW
DE DY IP L LE
LL M ME NG NR
OL RH SK SS ST
SY TF TN WA WN
WR WS WV IOM*

AREA 2

ORDER TUESDAY
DELIVERY MON/TUES

BA BS CF GL GU
HR LD NP OX PO**
RG SA SN SO SP
JERSEY/GUERNSEY & IOW*

AREA 3

ORDER WEDNESDAY
DELIVERY TUE/WED

AB BH BR CR DA
DD DG DT E EC
EH EN EX FK G
HA IG IV** KA KT
KW** KY ML N NW
PA** PH PL RM SE
SM SW TA TD TW
TQ TR UB W WC
WD ZE** IRELAND*

AREA 4

ORDER THURSDAY
DELIVERY WED/THUR

AL BB BD CA DN
DH DL FY HD HG
HP HU HX LA LN
LS LU MK NE NN
PE PR S SG SL
SR TS WF YO

* DELIVERY DAY TO 'OFFSHORE ACCOUNTS' WILL BE A DELIVERY TO THE NEAREST DOCK ON THAT DAY AND NOT DIRECTLY TO THE ORDER ADDRESS
** THESE POSTCODES WILL BE DELIVERED TO UNDER SPECIAL ARRANGEMENT DUE TO GEOGRAPHICAL LOCATION

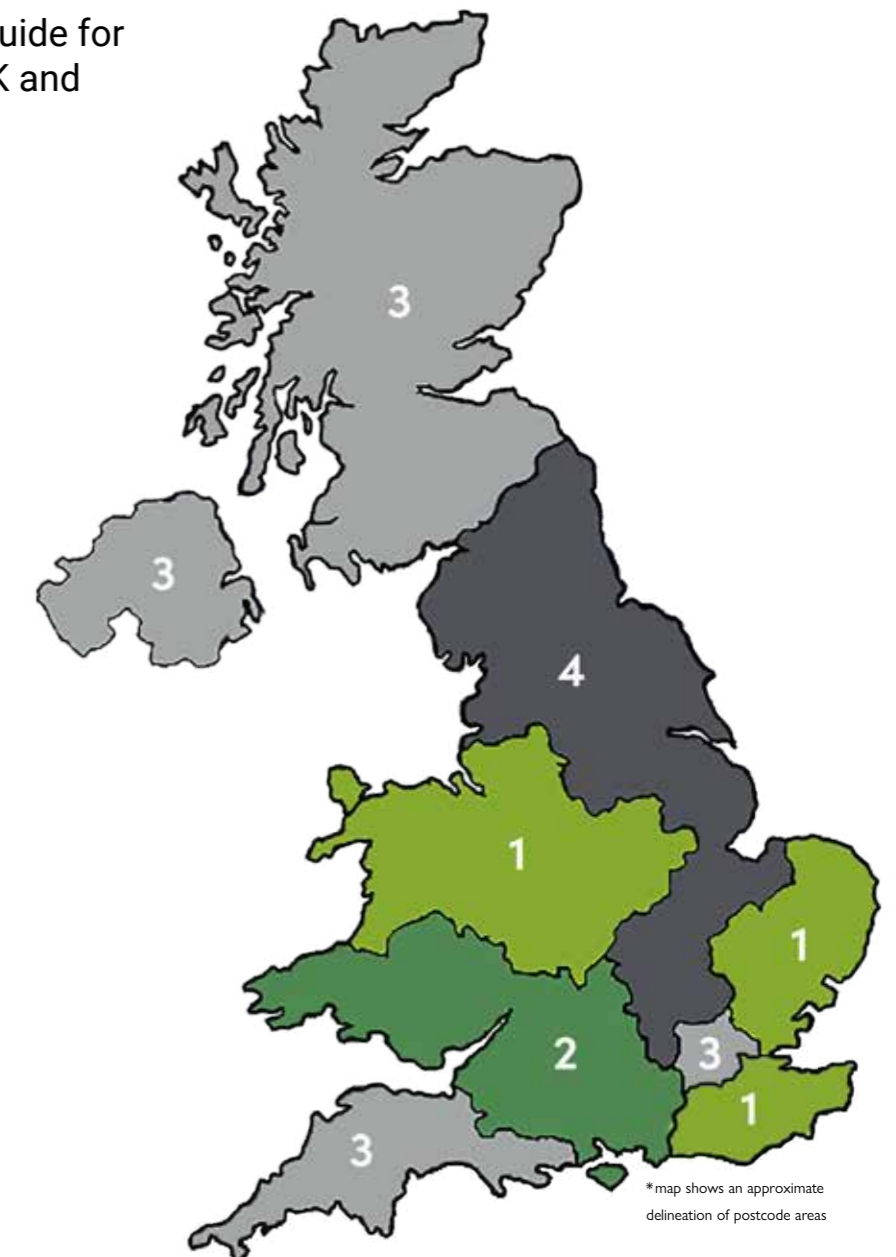

*map shows an approximate delineation of postcode areas

DELIVERY CHARGES - all products

PAYMENT TERMS - STRICTLY NETT MONTHLY

ORDER	DELIVERY CHARGE
A Orders that do not meet MCP	£75 carriage charge
B Charges for splitting packs (exc. Panels or Metpost products)	£25 charge except where indicated
C Metpost only orders	£200 min. order value

PLEASE INFORM THE SALES OFFICE IF THERE ARE ANY HEIGHT RESTRICTIONS IN YOUR AREA

Grange
DEFINING GARDENS
www.grangefencing.co.uk

REMEMBER - D-DAY
DAILY ORDER
DEADLINE:
11am



Grange

DEFINING GARDENS



Grange Fencing Ltd
Coates Quarry
Stretton Road
Much Wenlock
Shropshire
TF13 6DD

Customer Support: t.sales@grangefencing.co.uk
Website: www.grangefencing.co.uk